

# EOS Utility

Ver. 2.11



## Instruction Manual

### ● Content of this Instruction Manual

- EU is used for EOS Utility.
- Camera model is displayed as an icon.  
Example: EOS-1D X →
- displays the relevant camera model.
- The selection sequence of menus is displayed in ► procedures.  
(Example: Select the [Window] menu ► [Main Window].)
- Square brackets are used to indicate items such as menu names, button names and window names that appear on the computer screen.
- Text inside < > indicates a camera switch name or icon, or a keyboard key name.
- \*\* indicates a reference page.  
Click to move to the relevant page.
- : Marks information that should be read before use.
- : Marks additional information you may find helpful.

### ● Switching Between Pages

- Click on arrows on the bottom right of the screen.
  - : next page
  - : previous page
  - : return to a page you had previously displayed
- Click on the chapter headings on the right side of the screen to switch to the contents page of that chapter. Also, click the item you want to read about on the table of contents to move to the relevant page.

Introduction

Contents at a Glance

Downloading Images

Camera Settings

Remote Shooting

Preferences

Reference

Index

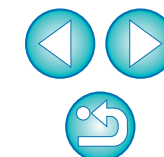

# READ CAREFULLY BEFORE USING!

## CANON SOFTWARE LICENSE AGREEMENT

IMPORTANT - READ THIS AGREEMENT BEFORE USING THE SOFTWARE ON THE CD-ROM IN THIS BOX. BY USING THE SOFTWARE, YOU AGREE TO BE BOUND BY THE TERMS OF THIS AGREEMENT.

This is a license agreement (the [Agreement]) between you and Canon Inc. ([Canon]).

IF YOU DO NOT AGREE TO THE TERMS AND CONDITIONS OF THIS AGREEMENT, DO NOT USE THE SOFTWARE PROGRAM ON THE CD-ROM AND THE USER MANUAL IN THIS BOX (COLLECTIVELY, THE [SOFTWARE]) AND RETURN THE SOFTWARE WITHIN 30 DAYS FROM THE DATE OF PURCHASE TO YOUR POINT OF PURCHASE FOR A REFUND.

In consideration of the right to use the SOFTWARE, you agree to abide by the terms and conditions of this Agreement.

1. LICENSE: Canon grants you the non-exclusive right to use the SOFTWARE only on a single computer. You may physically transfer the SOFTWARE from one computer to another provided that the SOFTWARE is used on only one computer at a time. You shall not install or use the SOFTWARE on a network, multiple CPU, multiple site arrangement, or any other hardware configuration where the SOFTWARE is accessible to more than one CPU or to more than one user.

YOU SHALL NOT ASSIGN, SUBLICENSE, RENT, LEASE, LOAN, CONVEY OR OTHERWISE USE, TRANSFER, COPY, TRANSLATE, CONVERT TO ANOTHER PROGRAMMING LANGUAGE, ALTER, MODIFY, DECOMPILE OR DISASSEMBLE THE SOFTWARE, IN WHOLE OR IN PART, EXCEPT AS EXPRESSLY PROVIDED IN THIS AGREEMENT.

2. BACK-UP COPY: You may make one copy of the SOFTWARE solely for back-up purposes, or copy the SOFTWARE onto the permanent storage device (e.g. a hard disk) of your computer and retain the original for back-up purposes. Any other copying of the SOFTWARE is a violation of this Agreement. You must reproduce and include the copyright notice on the back-up copy.

3. SUPPORT AND UPDATES: Canon is not responsible for providing maintenance or support for use of the SOFTWARE. No updates, fixes or support will be made available for the SOFTWARE.

4. LIMITED WARRANTY AND LIMITATION OF LIABILITY: It is your responsibility to choose, maintain and match the hardware and software components of your computer system. Thus Canon does not guarantee uninterrupted service or correction of errors or that the functions or performance of the SOFTWARE will meet your requirements. THE SOFTWARE IS LICENSED ON AN [AS IS] BASIS AND WITHOUT WARRANTY OF ANY KIND. The CD-ROM storing the SOFTWARE is warranted only against defective material under normal use for a period of ninety (90) days after purchase from an authorized Canon dealer as evidenced by your sales receipt. Your sole remedy for a defective CD-ROM shall be replacement of the same without charge when returned by you at your expense to your point of purchase and proven to be defective upon inspection. The replacement CD-ROM will be warranted for the remainder of the original ninety (90) day warranty period of the defective CD-ROM. The limited warranty does not apply if the failure of the CD-ROM resulted from accident, abuse or misapplication of the SOFTWARE and shall not extend to anyone other than the original user of the SOFTWARE.

EXCEPT AS SPECIFICALLY SET FORTH IN THIS PARAGRAPH 4, CANON, CANON'S SUBSIDIARIES, DISTRIBUTORS AND DEALERS DISCLAIM ALL WARRANTIES, EXPRESS OR IMPLIED, INCLUDING ANY WARRANTY OF MERCHANTABILITY OR FITNESS FOR A PARTICULAR PURPOSE, WITH RESPECT TO THE SOFTWARE.

NEITHER CANON NOR ANY OF CANON'S SUBSIDIARIES, DISTRIBUTORS OR DEALERS IS LIABLE FOR ANY DAMAGES HOWSOEVER CAUSED, INCLUDING WITHOUT LIMITATION, DIRECT, CONSEQUENTIAL OR INCIDENTAL LOSS OR DAMAGE INCLUDING LOSS OF

PROFITS, EXPENSE OR INCONVENIENCE HOWSOEVER CAUSED OR ARISING OUT OF THE SOFTWARE OR THE USE THEREOF.

NEITHER CANON, NOR ANY OF CANON'S SUBSIDIARIES, DISTRIBUTORS OR DEALERS SHALL HAVE ANY OBLIGATION TO INDEMNIFY YOU AGAINST ANY CLAIM OR SUIT BROUGHT BY A THIRD PARTY ALLEGING THAT THE SOFTWARE OR THE USE THEREOF INFRINGES ANY INTELLECTUAL PROPERTY OF SUCH THIRD PARTY.

5. TERM: This Agreement is effective upon your using the SOFTWARE and remains in effect until expiration of all copyright interests in the SOFTWARE unless earlier terminated. You may terminate this Agreement by destroying the SOFTWARE. This Agreement will also terminate without notice to you if you fail to comply with any of the terms of this Agreement and you must then promptly return the SOFTWARE. In addition, Canon may enforce its other legal rights.

6. U.S. GOVERNMENT RESTRICTED RIGHTS NOTICE: The SOFTWARE is provided with restricted rights. Use, duplication or disclosure is subject to restrictions as set forth in either subparagraph (c) (1) (ii) of the Rights in Technical Data and Computer software clause at DFARs 252.227-7013 or subparagraph (c) (1) and (2) of the Commercial Computer Software Restricted Rights Clause at FAR 52.227-19, as applicable.

7. SEVERABILITY: In the event that any provision of this Agreement is declared or found to be illegal by any court or tribunal of competent jurisdiction, such provision shall be null and void with respect to the jurisdiction of that court or tribunal and all the remaining provisions of this Agreement shall remain in full force and effect.

8. CONTROLLING LAW: The terms of this Agreement as it relates to purchases of the Software in the United States of America shall be governed and construed in all respects in accordance with the laws and regulations of the State of New York, without reference to choice of law principles. The terms of this Agreement as it relates to purchases of the Software in Canada shall be governed by the laws of the province of Ontario.

9. OWNERSHIP: All rights, including but not limited to copyrights and trade secret rights, to the SOFTWARE belong to Canon, its affiliated corporations and third party licensors. Your use of the SOFTWARE is subject to the United States, Canada and other applicable copyright and trademark laws and nothing in this Agreement constitutes a waiver of the rights of Canon, its affiliated corporations and third party licensors under such laws. Nothing contained in Paragraph 1 shall be construed to give Canon any ownership rights in any images, graphics or textual material that you save in connection with the Software.

10. ACKNOWLEDGEMENT: BY USING THE SOFTWARE, YOU ACKNOWLEDGE THAT YOU HAVE READ THIS AGREEMENT, UNDERSTOOD IT, AND AGREE TO BE BOUND BY ITS TERMS AND CONDITIONS. YOU ALSO AGREE THAT THIS AGREEMENT IS THE COMPLETE AND EXCLUSIVE STATEMENT OF AGREEMENT BETWEEN YOU AND CANON CONCERNING THE SUBJECT MATTER HEREOF AND SUPERSEDES ALL PROPOSALS OR PRIOR AGREEMENTS, VERBAL OR WRITTEN, AND ANY OTHER COMMUNICATIONS BETWEEN THE PARTIES RELATING TO THE SUBJECT MATTER HEREOF. NO AMENDMENT TO THIS AGREEMENT SHALL BE EFFECTIVE UNLESS SIGNED BY A DULY AUTHORIZED OFFICER OF CANON.

Introduction

Contents at a Glance

Downloading Images

Camera Settings

Remote Shooting

Preferences

Reference

Index

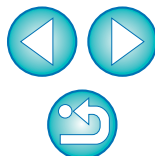

EOS Utility (hereinafter EU) is software for communication with your EOS DIGITAL camera. By connecting the camera and computer with the cable provided with the camera, you can download to your computer images saved in the camera's memory card as well as set various camera settings or shoot remotely from EU on your computer.

## Main Features of EU

From EU, you can control the camera remotely and perform the following main features.

- **Batch download to your computer images saved in the camera's memory card.**
  - You can also download to your computer only images you have selected.
- **Set various camera settings from your computer.**
- **Shoot remotely by controlling the camera from your computer.**
  - Remote Live View shooting – Shoot while checking your subject in real time on your computer.
  - You can also shoot remotely by operating the camera's shutter button.
  - Preset a time allowing the camera to shoot automatically with timer shooting.
- **When downloading images or shooting remotely, view/check images with the linked Digital Photo Professional.**

## System Requirements

<b>OS</b>	Mac OS X 10.6.8, 10.7
<b>Computer</b>	Macintosh with one of the above OS installed and a USB port as a standard feature
<b>CPU</b>	Intel processor
<b>RAM</b>	Minimum 1GB
<b>Interface</b>	Hi-Speed USB
<b>Display</b>	Resolution: 1024 × 768 or more Colors: Thousands or more

Check the Canon website for the latest system requirements, including supported OS versions.

## Supported Camera

Can be used for RAW images, JPEG images or MOV movies shot with the cameras below.

EOS-1D X	EOS-1D Mark IV
EOS-1Ds Mark III	EOS-1D Mark III
EOS 5D Mark III	EOS 5D Mark II
EOS 7D	EOS 60D
EOS 50D	EOS 40D
EOS REBEL T4i/650D	EOS REBEL T3i/600D
EOS REBEL T2i/550D	EOS REBEL T1i/500D
EOS DIGITAL REBEL XSi/450D	EOS REBEL T3/1100D
EOS DIGITAL REBEL XS/1000D	—

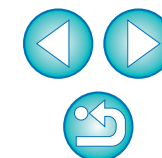



# Contents at a Glance

## Downloading images from your camera to a computer

- To batch download all the images to a computer → p.6
- To download to a computer selected images only → p.7
- To download images using a third-party card reader → p.10

## Camera settings from a computer

- To set the camera owner's name, copyright notice and date/time → p.12
- To set a Picture Style and apply to the camera → p.16
- To apply a Picture Style file to the camera → p.18
- To register a personal white balance in the camera → p.20
- To set a JPEG quality and apply to the camera → p.21
- To adjust a white balance setting and apply to the camera → p.22
- To register lens aberration correction/peripheral illumination correction data for the lens in the camera → p.22
- To set My Menu and apply to the camera → p.24

## Remote shooting

- To shoot by controlling the camera from a computer (Remote Live View shooting) → p.27
- To shoot with accurate horizontal/vertical alignment → p.43
- To change the aspect ratio and shoot → p.44
- To shoot with another image displayed as overlay to align several images at the same angle → p.47
- To shoot by operating the camera → p.52
- To shoot movies → p.53
- To shoot with timer → p.64
- To shoot with flash → p.66

## Functions for use with other accessories sold separately

- To shoot with the Wireless File Transmitter WFT-E2, WFT-E2 II, WFT-E3, WFT-E4, WFT-E4 II, WFT-E5, WFT-E6, or WFT-E7 and check the images in real time → p.81
- To start up the WFT-E2, WFT-E2 II, WFT-E3, WFT-E4, WFT-E4 II, or WFT-E5 software from EU → p.82

## Other

- To register background music to the camera's memory card → p.70

Introduction

Contents at a Glance

Downloading Images

Camera Settings

Remote Shooting

Preferences

Reference

Index

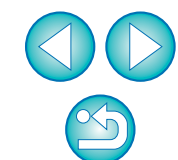

# 1 Downloading Images to your Computer



Basic operation such as preparing for downloading images to your computer (connecting your camera and computer), starting up EU, downloading images from your camera to your computer and quitting EU are explained here.

Connecting the Camera and Computer.....	5
Starting up EU .....	6
Batch Downloading Images to Your Computer .....	6
Downloading Selected Images to Your Computer.....	7
Using the Camera to Download Images to Your Computer.....	9
Downloading Images with a Card Reader.....	10
Downloading Images Using Digital Photo Professional ...	10
Downloading Images Using ImageBrowser EX ....	10
Downloading Images without Using Canon Software...	10
Quitting EU .....	10

Introduction

Contents at a Glance

1  
Downloading Images

2  
Camera Settings

3  
Remote Shooting

4  
Preferences

Reference

Index

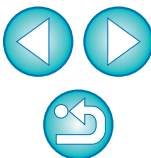

# Connecting the Camera and Computer

To download to your computer images shot with your camera, you will need to connect your camera and computer using the interface cable provided with your camera.

## 1 Connect the large plug of the cable into the USB port of your computer.

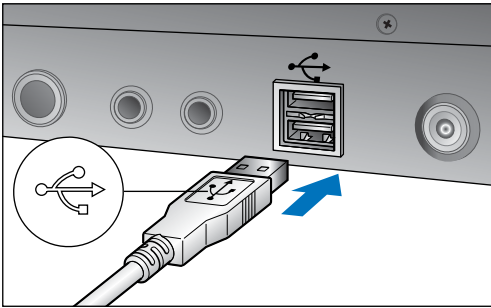

- For the location and direction of the USB port, refer to the computer User's Manual.

## 2 Connect the small plug of the cable into the terminal on your camera.

- Once the plug is connected to the camera according to the steps for your camera model, preparation for downloading images is complete. Continue with "Starting up EU".

1D Mk IV

- With the < USB > mark on the plug facing the back of the camera, connect it to the camera's <A/V OUT / DIGITAL> terminal.

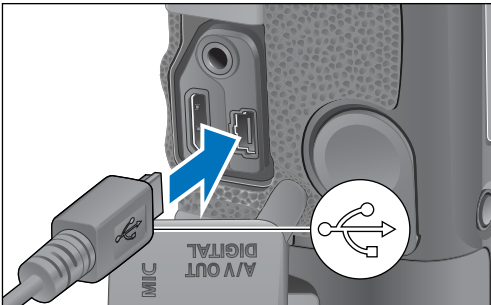

Cameras other than 1D Mk IV

- With the < USB > mark on the plug facing the front of the camera, connect it to the camera's < USB > terminal or <A/V OUT / DIGITAL> terminal.

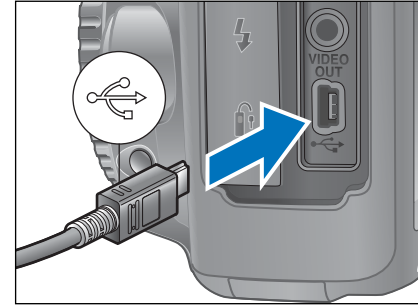

COPY

Introduction

Contents at a Glance

Downloading Images

Camera Settings

Remote Shooting

Preferences

Reference

Index



With 1D X 1D Mk IV 1Ds Mk III 1D Mk III, you can fix the plug to the camera with the cable protector to prevent the plug from disconnecting. For details on using, see p.84 to p.86.

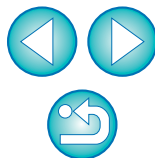

# Starting up EU

When the camera's power switch is set to < ON >, EU will start up, and the camera and computer will be able to communicate.

## Set the camera's power switch to < ON >.

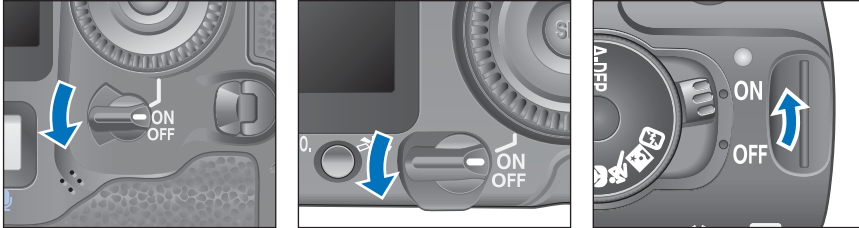

## EU Main window



- EU starts up, the main window appears, and your camera and computer can now communicate. Continue with “Batch Downloading Images to Your Computer”.
- The camera's LCD monitor turns on when EU starts up.
- For cameras other than 1D Mk IV, 7D, 60D, REBELT4i, 650D, REBELT3i, 600D, REBELT2i, 550D, REBELT3, 1100D, you can operate the camera and download images saved on the memory card inserted in the camera to your computer. Refer to your camera's Instruction Manual for details.
- REBELT1i, 500D cannot communicate with EU if the camera's Mode Dial is set to < P >. Set the Mode Dial to a mode other than < P >.

# Batch Downloading Images to Your Computer

You can batch download to your computer all the images saved on the memory card inserted in the camera that you have not already downloaded.

The downloaded images are sorted by date into folders and are then displayed in the main window of Digital Photo Professional (RAW image processing, viewing and editing software) (hereinafter DPP), which is linked to start up automatically, where you can check them immediately.

## 1 Click [Starts to download images].

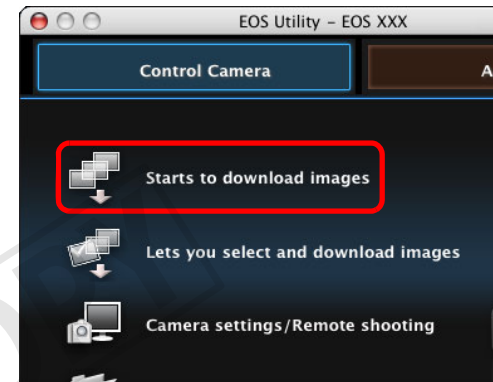

## Save File dialog box

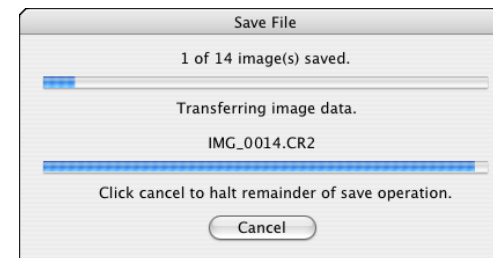

- The [Save File] dialog box appears and image downloading to your computer begins.
- The downloaded images are saved in the [Pictures] folder.
- When all images have been downloaded, DPP starts up automatically and the downloaded images are displayed in DPP's main window.

Introduction

Contents at a Glance

Downloading Images

Camera Settings

Remote Shooting

Preferences

Reference

Index

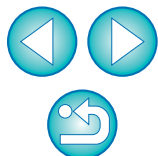

## 2 Check the downloaded images.

### DPP Main window



- Check the downloaded images in DPP.  
For details on using DPP, refer to the “Digital Photo Professional Instruction Manual” (PDF electronic manual).
- Continue with “Quitting EU” (p.10).

## Downloading Selected Images to Your Computer

From the images saved in your camera's memory card, you can select the ones you want and download them to your computer.

### 1 Click [Lets you select and download images].



→ A viewer window appears and the images in the memory card are displayed.

- When you download images, you can change the software that starts up from DPP to ImageBrowser EX or other software in preferences ([Linked Software] window) (p.77).
- You can change the save destination for images downloaded and images to download in preferences ([Destination Folder] window, [Download Images] window) (p.74, p.75).
- Downloading movie files may take some time due to the large file size.

Introduction

Contents at a Glance

Downloading Images

Camera Settings

Remote Shooting

Preferences

Reference

Index

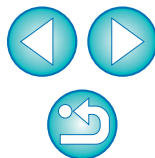



## 2 View the images and checkmark images to download.

### Viewer window

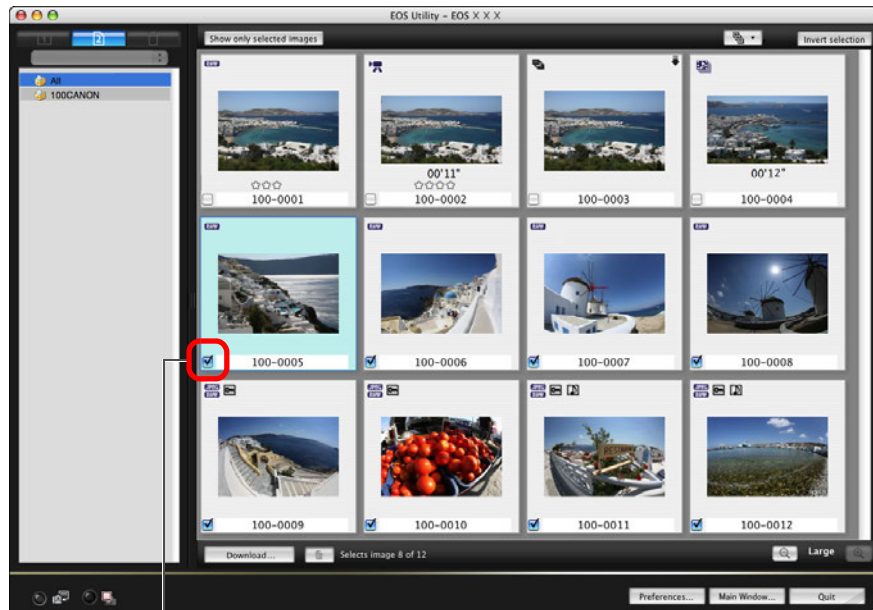

Add check mark

You can click the [  ] button and extract images by a variety of criteria to select images to download.

## 3 Click the [Download] button.

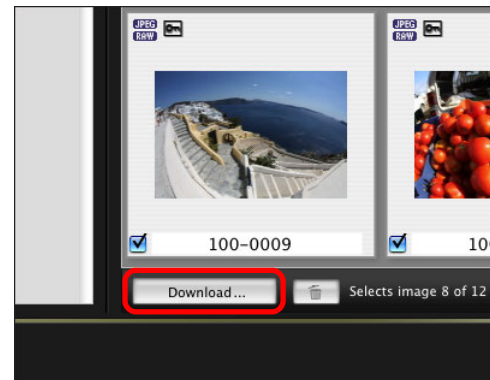

→ The [Download image] dialog box appears.

## 4 Specify the save destination and then click the [OK] button.

Displays the save destination on the computer

### Download image dialog box

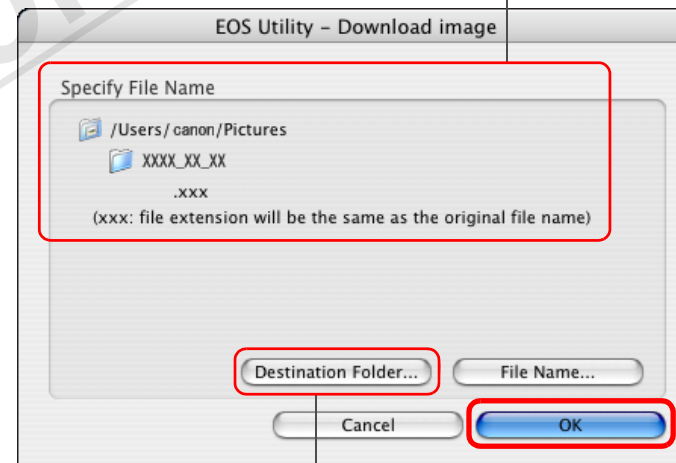

Specify the save destination

→ The [Save File] dialog box appears and image downloading to your computer begins.

Introduction

Contents at a Glance

Downloading Images

Camera Settings

Remote Shooting

Preferences

Reference

Index



→ The images downloaded to your computer are displayed in the [Quick Preview] window.



- The [Quick Preview] window allows you to quickly review the downloaded images. You can also resize the [Quick Preview] window.
- When all images have been downloaded, DPP starts up automatically and the downloaded images are displayed.
- To switch to the main window, click the [Main Window] button in the viewer window.

## Using the Camera to Download Images to Your Computer

If your camera has a direct image transfer function, you can use it to download to your computer the images saved on the memory card inserted in the camera. Refer to your camera's Instruction Manual for details on its direct image transfer function.



- This function is compatible with 1D X, 1Ds Mk III, 1D Mk III, 5D Mk III, 5D Mk II, 50D, 40D, REBELT1i, 500D, REBELXSi, 450D, REBELXS, 1000D.

**1** Connect your camera and computer, and then start up EU (p.5).

**2** Operate the camera to transfer the images directly.

- The images in the camera are saved to your computer.
- When all images have been downloaded, Digital Photo Professional starts up and the downloaded images are displayed.



- In step 2, you can batch checkmark several images in sequence. After clicking the first image you want to download, hold the < shift > key and click the last image, and [   ] will be displayed. By clicking the [  ] button, the selected images will be checkmarked in a batch.
- For a list of viewer window functions, see p.88.

Introduction

Contents at a Glance

Downloading Images

Camera Settings

Remote Shooting

Preferences

Reference

Index

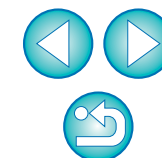

## Downloading Images with a Card Reader

For users with a third-party card reader, you can also download to your computer images stored in a memory card using the card reader. However, EU does not support image downloading using a card reader. For this reason, when downloading images using a card reader, use one of the following 3 procedures.

## Downloading Images Using Digital Photo Professional

You can use DPP to download to your computer shot images from a memory card inserted in a third-party card reader connected to your computer.

For detailed instructions, refer to “Downloading Images Using Your Card Reader” in the “Digital Photo Professional Instruction Manual” (PDF electronic manual).

## Downloading Images Using ImageBrowser EX

You can use ImageBrowser EX to download to your computer shot images from a memory card inserted in a third-party card reader connected to your computer.

For detailed instructions, refer to “ImageBrowser EX User Guide” (PDF electronic manual).

## Downloading Images without Using Canon Software

To download images with a card reader without using Canon software such as DPP or ImageBrowser EX, copy to your computer the [DCIM] folder in the memory card.

For more details about folder structures and files in the memory card, see [p.83](#).

## Quitting EU

1 Click the [Quit] button.



→ The window closes and EU quits.

2 Turn the camera's power switch to < OFF >.

3 Disconnect the cable from the camera and computer.

● Do not pull on the cable; hold the plug and pull out.

Introduction

Contents at a Glance

Downloading Images

Camera Settings

Remote Shooting

Preferences

Reference

Index

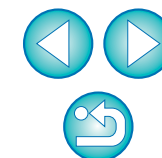

# 2 Setting the Camera from Your Computer



This section explains how to set the camera's functions from EU.

Setting the Camera Owner's Name, Copyright Notice and Date/Time.....	12
Available Settings by Camera Model.....	13
Setting up Camera Functions .....	14
Available Settings by Camera Model.....	15
Setting Picture Styles and Applying to the Camera....	16
Selecting a Picture Style and Applying to the Camera.....	16
Changing Picture Style Settings and Applying to the Camera.....	17
Applying Picture Style Files to the Camera .....	18
Saving White Balance to your Computer .....	19
Registering Personal White Balance in the Camera ...	20
Setting JPEG Quality and Applying to the Camera ....	21
Adjusting White Balance and Applying to the Camera...	22
Registering Lens Aberration Correction/Peripheral Illumination Correction Data for the Lens in the Camera.....	22
Setting My Menu and Registering to the Camera .....	24

Introduction

Contents at a Glance

Downloading Images

Camera Settings

Remote Shooting

Preferences

Reference

Index

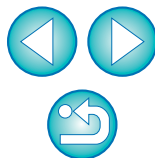

# Setting the Camera Owner's Name, Copyright Notice and Date/Time

You can set and apply to the camera, the camera owner's name, copyright notice and date/time recorded as shooting information in shot images.

- 1 Connect your camera and computer, and then start up EU (p.5).
- 2 Click [Camera settings/Remote shooting].



→ The capture window appears.

- 3 Click the [  ] button.  
Capture window

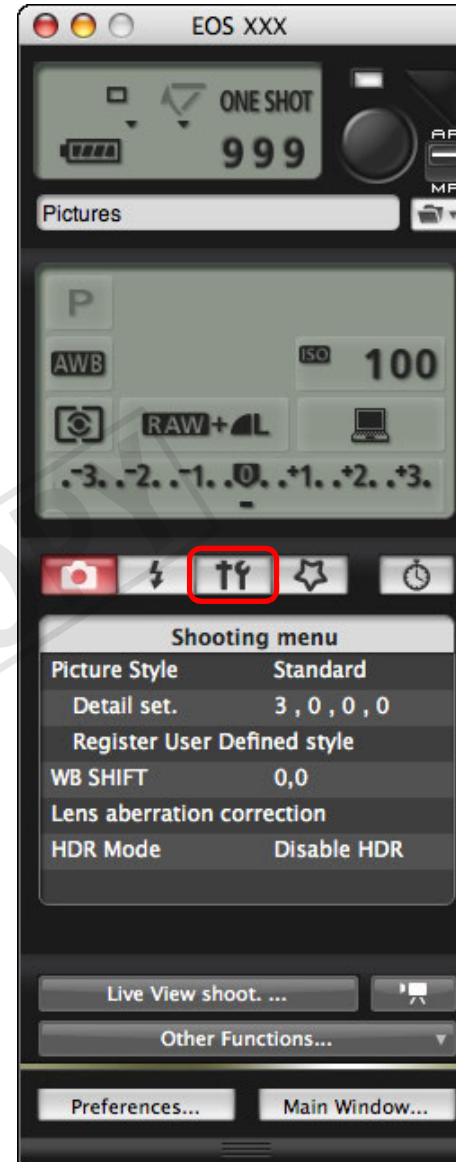

→ The [Set-up menu] appears.

Introduction

Contents at a Glance

Downloading Images

Camera Settings

Remote Shooting

Preferences

Reference

Index

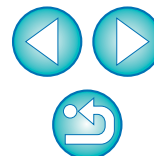

# 4 Click the required setting and specify each one.

## Set-up menu

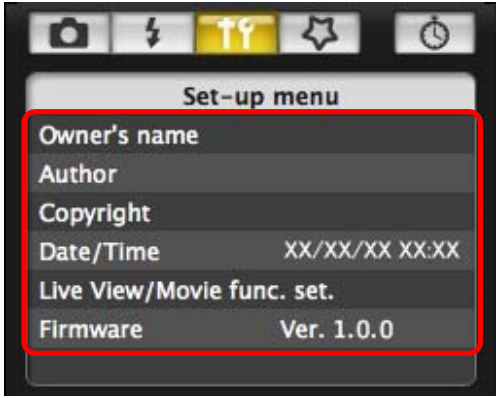

- Available settings are displayed for the camera that is connected. For more details, see "Available Settings by Camera Model".

For a list of the capture window functions, see p.91.

## Available Settings by Camera Model

Setting	1Ds Mk III	1D Mk III	1D X	1D Mk IV	5D Mk III	5D Mk II	7D	60D	40D	50D	REBELT4i	REBELXSi	650D	REBELT3i	450D	600D	REBELT2i	REBELXS	550D	REBELT1i	1000D	500D	REBELT3	1100D
Owner's name	<input type="radio"/>	<input type="radio"/>	<input type="radio"/>	<input type="radio"/>	<input type="radio"/>	<input type="radio"/>	<input type="radio"/>	<input type="radio"/>	<input type="radio"/>	<input type="radio"/>	<input type="radio"/>	<input type="radio"/>	<input type="radio"/>	<input type="radio"/>	<input type="radio"/>	<input type="radio"/>	<input type="radio"/>	<input type="radio"/>	<input type="radio"/>	<input type="radio"/>	<input type="radio"/>	<input type="radio"/>	<input type="radio"/>	<input type="radio"/>
Author*1	-	<input type="radio"/>	<input type="radio"/>	<input type="radio"/>	<input type="radio"/>	<input type="radio"/>	<input type="radio"/>	<input type="radio"/>	<input type="radio"/>	<input type="radio"/>	<input type="radio"/>	<input type="radio"/>	<input type="radio"/>	<input type="radio"/>	<input type="radio"/>	<input type="radio"/>	<input type="radio"/>	<input type="radio"/>	<input type="radio"/>	<input type="radio"/>	<input type="radio"/>	<input type="radio"/>	<input type="radio"/>	<input type="radio"/>
Copyright holder (copyright notice)*1	-	<input type="radio"/>	<input type="radio"/>	<input type="radio"/>	<input type="radio"/>	<input type="radio"/>	<input type="radio"/>	<input type="radio"/>	<input type="radio"/>	<input type="radio"/>	<input type="radio"/>	<input type="radio"/>	<input type="radio"/>	<input type="radio"/>	<input type="radio"/>	<input type="radio"/>	<input type="radio"/>	<input type="radio"/>	<input type="radio"/>	<input type="radio"/>	<input type="radio"/>	<input type="radio"/>	<input type="radio"/>	<input type="radio"/>
Date/Time/Zone*2	<input type="radio"/>	<input type="radio"/>	<input type="radio"/>	<input type="radio"/>	<input type="radio"/>	<input type="radio"/>	<input type="radio"/>	<input type="radio"/>	<input type="radio"/>	<input type="radio"/>	<input type="radio"/>	<input type="radio"/>	<input type="radio"/>	<input type="radio"/>	<input type="radio"/>	<input type="radio"/>	<input type="radio"/>	<input type="radio"/>	<input type="radio"/>	<input type="radio"/>	<input type="radio"/>	<input type="radio"/>	<input type="radio"/>	<input type="radio"/>
Live View/Movie func. set.*3	<input type="radio"/>	<input type="radio"/>	<input type="radio"/>	<input type="radio"/>	<input type="radio"/>	<input type="radio"/>	<input type="radio"/>	<input type="radio"/>	<input type="radio"/>	<input type="radio"/>	<input type="radio"/>	<input type="radio"/>	<input type="radio"/>	<input type="radio"/>	<input type="radio"/>	<input type="radio"/>	<input type="radio"/>	<input type="radio"/>	<input type="radio"/>	<input type="radio"/>	<input type="radio"/>	<input type="radio"/>	<input type="radio"/>	<input type="radio"/>
Firmware	<input type="radio"/>	<input type="radio"/>	<input type="radio"/>	<input type="radio"/>	<input type="radio"/>	<input type="radio"/>	<input type="radio"/>	<input type="radio"/>	<input type="radio"/>	<input type="radio"/>	<input type="radio"/>	<input type="radio"/>	<input type="radio"/>	<input type="radio"/>	<input type="radio"/>	<input type="radio"/>	<input type="radio"/>	<input type="radio"/>	<input type="radio"/>	<input type="radio"/>	<input type="radio"/>	<input type="radio"/>	<input type="radio"/>	<input type="radio"/>

### Owner's name

- You can enter and set up to 31 characters as the camera owner's name.

### Author\*1

- You can enter and set up to 63 characters or symbols, including a prefix, as the author's name.

### Copyright holder (copyright notice)\*1

- You can enter and set up to 63 characters or symbols, including a prefix, as the photo creation's copyright holder (copyright notice).

### Date/Time/Zone\*2

- You can set the camera's date/time and the time zone where images were shot.
- You can retrieve the computer's system time to sync the camera's date and time.
- You can set and cancel daylight savings time on **1D X** **5D Mk III** **7D** (firmware version 2.0.0 or later) **REBELT4i** **650D**.

### Live View/Movie func. set.\*3

- You can set whether the Live View function settings or Movie function settings (p.27, p.53) are available or not.

### Firmware

- You can display the version of the camera's firmware.
- You can update the firmware by clicking on this item.
- For more details on updating firmware, refer to the Canon's website.

\*1 When the author or copyright holder (copyright notice) set is not displayed in full, moving the cursor to the displayed setting item will display all the entered information as a pop-up.

\*2 Area setting is for **1D X** **5D Mk III** **7D** (firmware version 2.0.0 or later) **REBELT4i** **650D** only.

\*3 Movie function settings are for **1D X** **1D Mk IV** **5D Mk III** **5D Mk II** **7D** **60D** **REBELT4i** **650D** **REBELT3i** **600D** **REBELT2i** **550D** **REBELT1i** **500D** **REBELT3** **1100D** only.

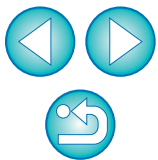

# Setting up Camera Functions

You can set and apply to the camera Picture Styles, personal white balance, JPEG quality and white balance adjustment.

- 1 Connect your camera and computer, and then start up EU (p.5).
- 2 Click [Camera settings/Remote shooting].



→ The capture window appears.

- 3 Click the [  ] button.



→ The [Shooting menu] appears.

Introduction

Contents at a Glance

Downloading Images

Camera Settings

Remote Shooting

Preferences

Reference

Index

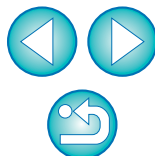

## 4 Click the required setting and specify each one.

### Shooting menu

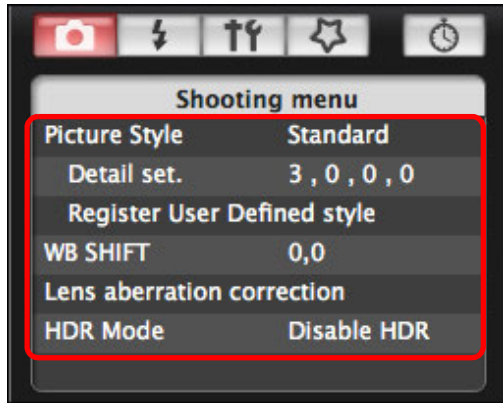

- Available settings are displayed for the camera that is connected. For more details, see “Available Settings by Camera Model”.

 For a list of the capture window functions, see [p.91](#).

## Available Settings by Camera Model

Setting	Camera Models			
	1D X 1D Mk IV 1Ds Mk III 1D Mk III	5D Mk III 7D 50D 650D 600D 550D 500D 1100D	5D Mk II 60D REBELT4i REBELT3i REBELT2i REBELT1i REBELT3	40D REBELXSi 450D REBELXS 1000D
Picture Style	○	○	○	○
Personal white balance	△*1	—	—	—
JPEG quality	○	—	—	—
White balance adjustment	○	○	○	○
Registering lens aberration correction/peripheral illumination correction data	△*1	○	—	—
HDR Shooting	—	△*2	—	—

△\*1 Setting is possible for **1D X** **1D Mk IV**, but not for other models.

△\*2 Setting is possible for **5D Mk III**, but not for other models.

### Picture Style

- You can set a Picture Style and apply it to the camera, in the same way as operating from the camera ([p.16](#)).

### Personal white balance

- You can register to the camera a personal white balance file ([p.20](#)).

### JPEG quality

- You can set the JPEG image quality and apply it to the camera, in the same way as operating from the camera ([p.21](#)).

### White balance adjustment

- You can adjust the white balance, in the same way as operating from the camera ([p.22](#)).

### Registering lens aberration correction/peripheral illumination correction data

- You can register lens aberration correction/peripheral illumination correction data for the lens to the camera or delete registered data from the camera ([p.22](#)).

### HDR (High Dynamic Range) shooting

- You can shoot photos with a wide dynamic range where clipping in highlights and shadows has been reduced, and photos that appear like paintings ([p.33](#)).

Introduction

Contents at a Glance

Downloading Images

Camera Settings

Remote Shooting

Preferences

Reference

Index

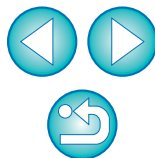



## Setting Picture Styles and Applying to the Camera

You can set and apply Picture Styles to the camera, in the same way as operating from the camera. You can change the values for [Sharpness], [Contrast], [Saturation] and [Color tone] of each Picture Style and register up to three of your own Picture Styles in the camera as user-defined settings.

You can also register Picture Style files in the camera as user-defined settings you have downloaded from the Canon's website or created with Picture Style Editor (Picture Style file creating software) (hereinafter PSE) and saved to your computer.

For **1D X** **1D Mk IV** **5D Mk III** **7D** **60D** **REBEL4i** **650D** **REBEL3i** **600D** **REBEL2i** **550D** **REBEL3** **1100D**, registering Picture Styles may take some time.

## Selecting a Picture Style and Applying to the Camera

1 Click [Picture Style].

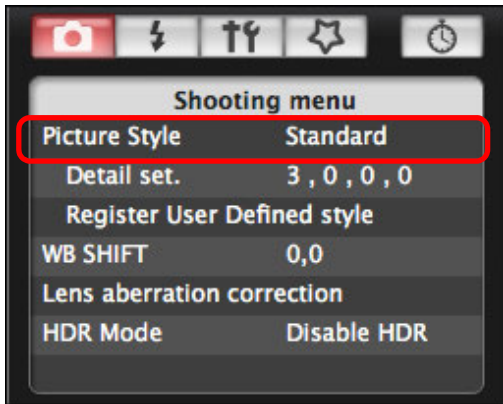

→ The [Picture Style] window appears.

2 Click the Picture Style to be set in the camera.

Picture Style window

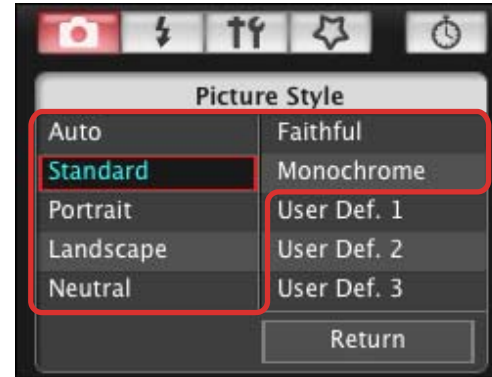

→ The setting is applied to the camera and the display returns to the [Shooting menu].

COPY

[Auto] appears for Picture Styles only with **1D X** **5D Mk III** **REBEL4i** **650D** **REBEL3i** **600D**.

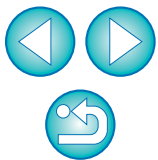

## Changing Picture Style Settings and Applying to the Camera

You can set your own Picture Style [Sharpness], [Contrast], [Saturation] and [Color tone] and apply them to the camera, in the same way as operating from the camera.

### 1 Click [Detail set.].

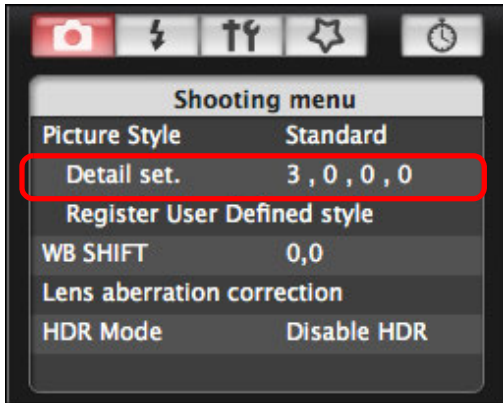

→ The [Detail set.] dialog box appears.

### 2 Set by clicking the pointer on the slider for each item.

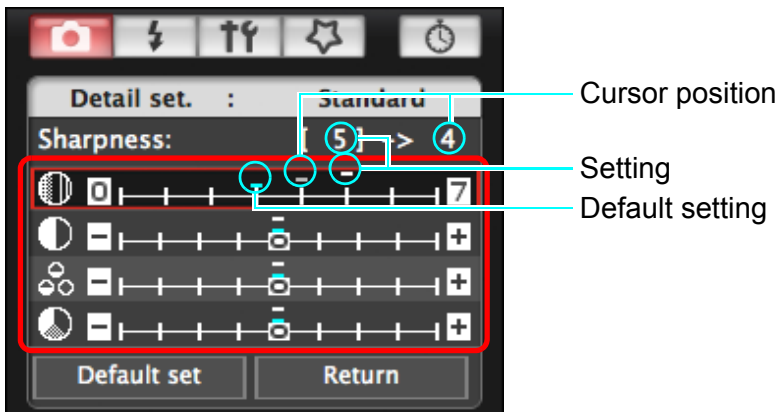

→ If you select [Monochrome] for the Picture Style (p.16), the [Filter effect] and [Toning effect] list boxes appear.

### 3 Click the [Return] button.



→ The settings are applied to the camera, and the display returns to the [Shooting menu].

Introduction

Contents at a Glance

Downloading Images

Camera Settings

Remote Shooting

Preferences

Reference

Index

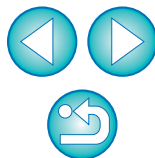

## Applying Picture Style Files to the Camera

You can register up to three Picture Style files downloaded from the Canon's website or created with PSE and saved to your computer, as user-defined settings in your camera.

### 1 Click [Register User Defined style].

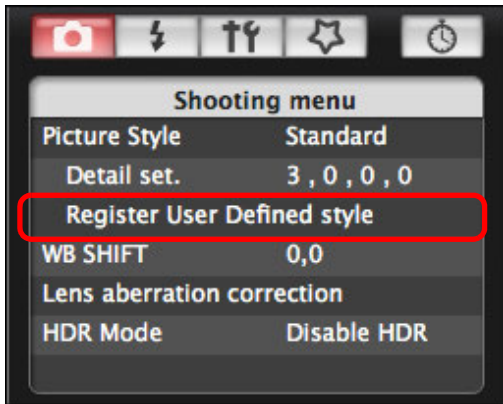

→ The [Register User Defined style] dialog box appears.

### 2 Select a tab from one of [User Defined 1] to [User Defined 3].



### 3 Click the [Load Picture Style] button.



→ The Load Picture Style window appears.

### 4 Select a Picture Style file and then click the [Open] button.

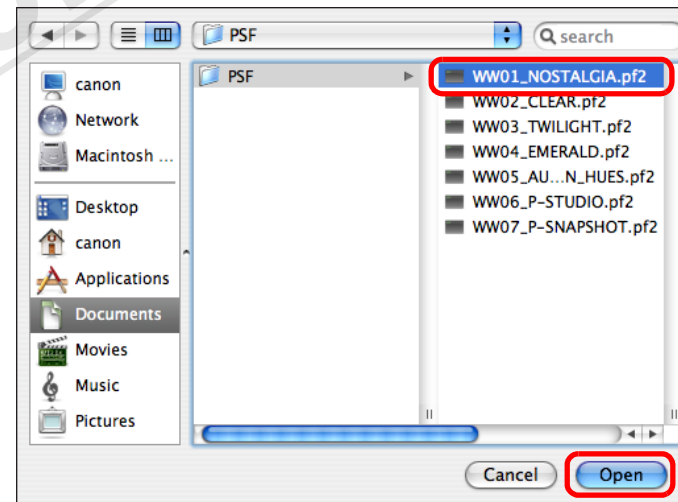

→ The Picture Style file is loaded.

Introduction

Contents at a Glance

Downloading Images

Camera Settings

Remote Shooting

Preferences

Reference

Index

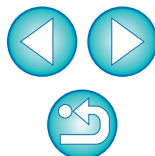

## 5 Click the [OK] button.

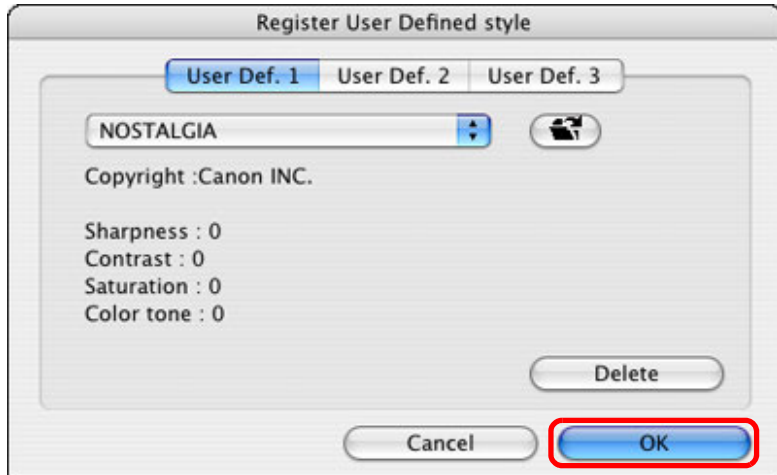

→ The Picture Style file is registered in the camera.

## Saving White Balance to your Computer



You can save the adjustment results for an image's white balance to your computer as a white balance file (extension ".WBD"). White balance files saved to your computer can be registered in the camera as personal white balances (p.20).

Start by registering a white balance in your camera after adjusting it in the [Remote Live View window] or [Test Shooting] window.

### 1 Click [Personal WB].

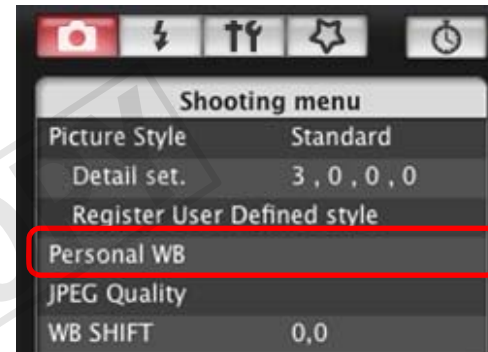

→ The [Personal white balance settings] dialog box appears.

- A Picture Style file is an extended function of Picture Style. For more details on Picture Style files, refer to the Canon's website.
- The Picture Style files that you can apply to the camera are files with the ".PF2" extension only.
- For details on using PSE, refer to the "Picture Style Editor Instruction Manual" (PDF electronic manual).

Introduction

Contents at a Glance

Downloading Images

Camera Settings

Remote Shooting

Preferences

Reference

Index

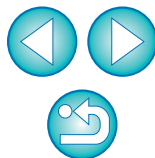

2 Select the white balance to be saved to your computer and click the [Save] button.

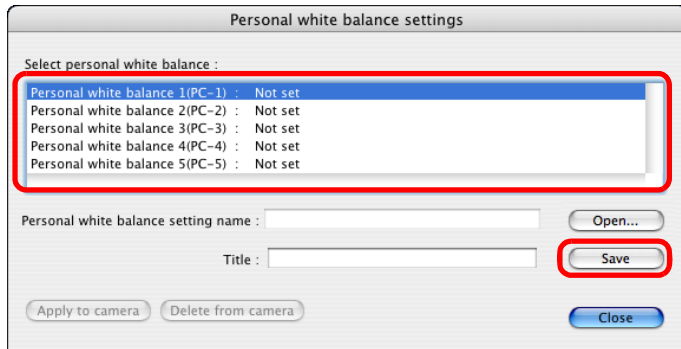

3 In the window that appears, enter a filename, select a save destination, and then click the [Save] button.

→ The white balance file is saved to your computer.

## Registering Personal White Balance in the Camera



White balance files created by adjusting the white balance of an image and saving the results can be registered in the camera as personal white balances.

1 Click [Personal WB].

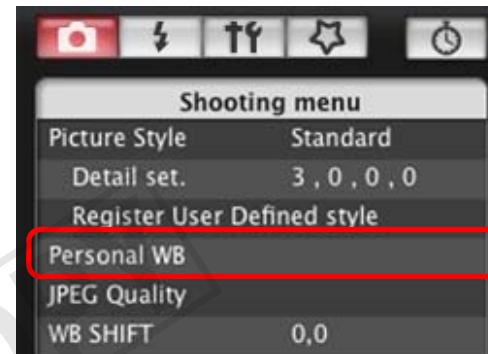

→ The [Personal white balance settings] dialog box appears.

2 Select the personal white balance to be registered and click the [Open] button.

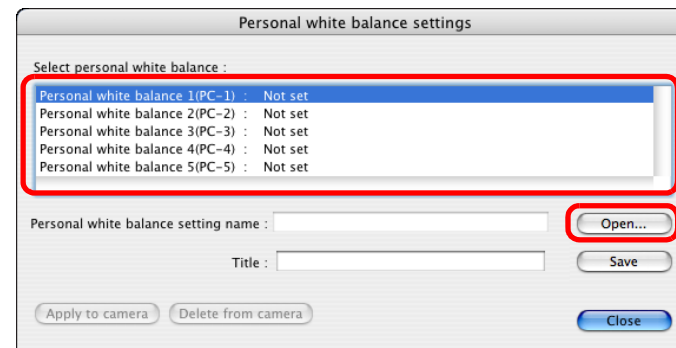

→ The file selection window appears.

Introduction

Contents at a Glance

Downloading Images

Camera Settings

Remote Shooting

Preferences

Reference

Index

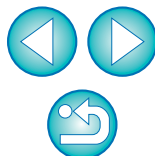

### 3 Open the folder containing the saved white balance file, select the file and then click the [Open] button.

- The white balance file is loaded.
- The white balance files that you can register to the camera are files with the “.WBD” extension.

### 4 Enter a title into the [Title] input field.

### 5 Click the [Apply to camera] button.

- The personal white balance is registered on the camera.
- To register another setting, repeat step 2 to step 5.

### 6 Click the [Close] button.

- The [Personal white balance settings] dialog box closes and the display returns to the [Shooting menu].

### 7 Select a registered personal white balance on the camera.

- Select a registered personal white balance as the white balance.
- For selecting personal white balance or manual white balance, refer to “Setting the White Balance” in the camera’s Instruction Manual provided with your camera.

## Setting JPEG Quality and Applying to the Camera



You can set the JPEG image quality and apply it to the camera, in the same way as operating from the camera.

### 1 Click [JPEG quality].

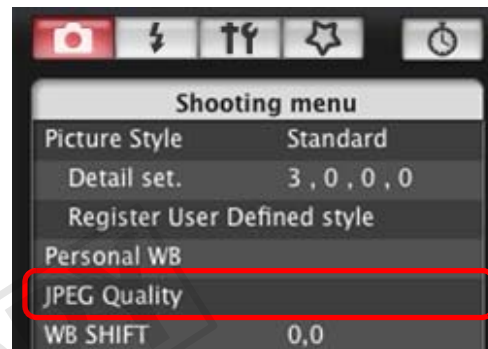

- The [JPEG Quality] window appears.

### 2 Click the setting position.

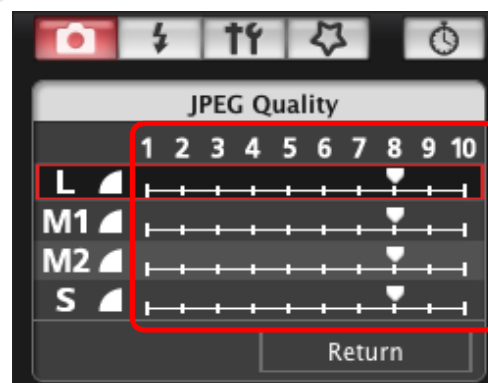

- The settings are applied to the camera.
- Higher values give a lower compression ratio and higher image quality for any size.

### 3 Click [Return].

- The display returns to the [Shooting menu].

Introduction

Contents at a Glance

Downloading Images

Camera Settings

Remote Shooting

Preferences

Reference

Index

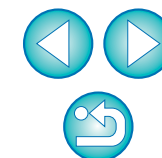

## Adjusting White Balance and Applying to the Camera

You can adjust white balance, in the same way as operating from the camera.

### 1 Click [WB SHIFT].

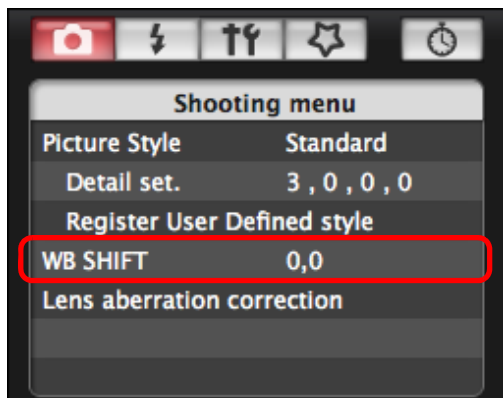

→ The [WB SHIFT] window appears.

### 2 Click the compensation position.

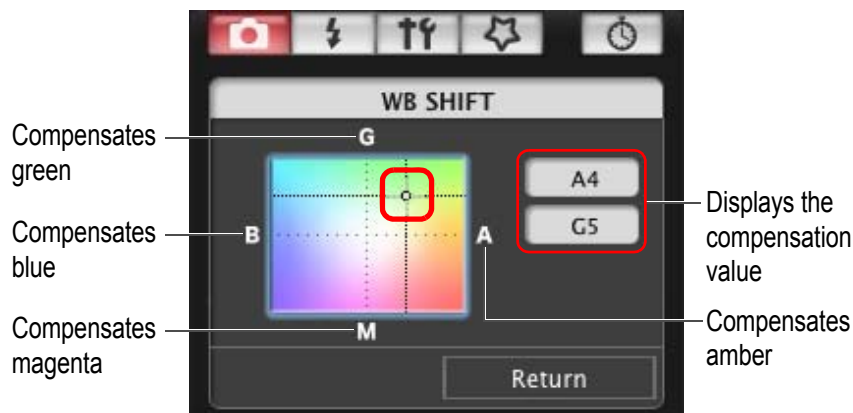

→ The settings are applied to the camera.

### 3 Click [Return].

→ The display returns to the [Shooting menu].

- To revert the corrected values to the original values, follow the procedure in step 2.

## Registering Lens Aberration Correction/Peripheral Illumination Correction Data for the Lens in the Camera

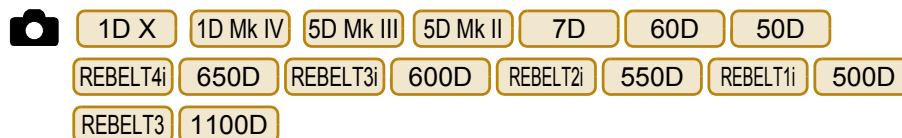

You can register lens aberration correction/peripheral illumination correction data for the lens to the camera, or delete registered data from the camera.

For cameras where [Lens aberration correction] is displayed in the [Shooting menu], data is registered or deleted for lens peripheral illumination correction, distortion correction, and chromatic aberration correction. (Data for distortion correction and chromatic aberration correction is used during RAW processing on the camera.)

For cameras where [Peripheral illumin. correct.] is displayed in the menu, only lens peripheral illumination correction data is registered or deleted.

### 1 Click [Lens aberration correction] or [Peripheral illumin. correct.].

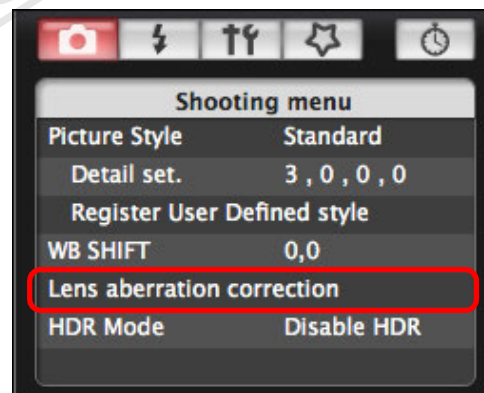

→ The [Register lens aberration correction data] window or [Register peripheral illumination correction data] window appears. Lenses for which correction data is registered in the camera are displayed with a check mark.

- Window names that appear and data to be registered in the camera differ depending on the camera. However, the following steps are the same.

Introduction

Contents at a Glance

Downloading Images

Camera Settings

Remote Shooting

Preferences

Reference

Index

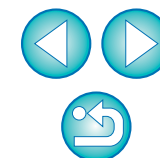

## 2 Select the lens category for which you want to register correction data.

Register lens aberration correction data/Register peripheral illumination correction data window

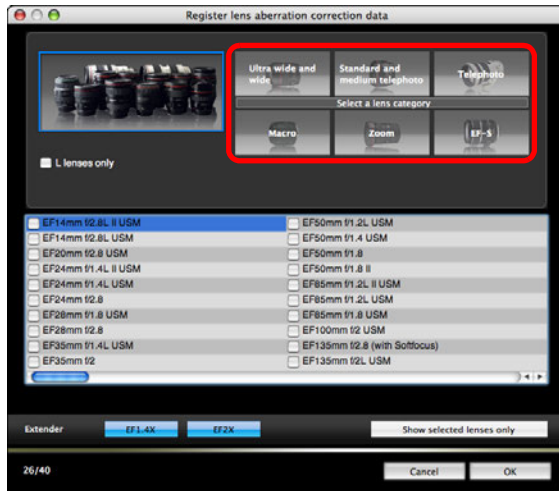

→ A list appears showing only the selected lens category.

## 3 Select the lens for which you want to register correction data and click the [OK] button.

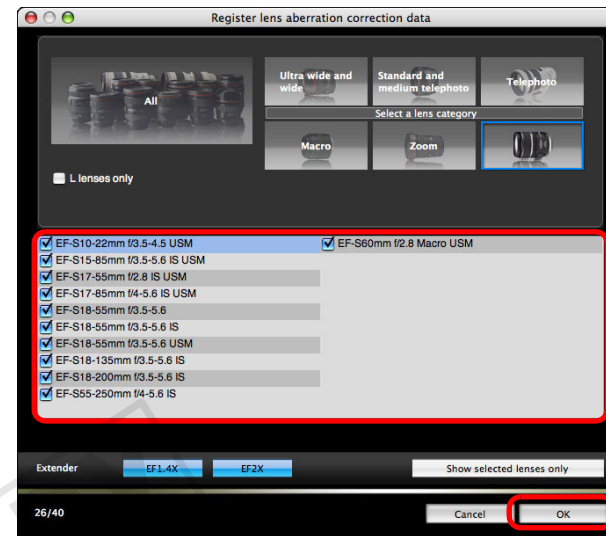

→ The correction data for the selected lens is registered in the camera.

● You can delete correction data from the camera by removing the check mark from the registered lens and clicking the [OK] button.



- For a list of the [Register lens aberration correction data] window or [Register peripheral illumination correction data] window functions, see p.89.
- Lens names displayed in the [Register lens aberration correction data] window or [Register peripheral illumination correction data] window may be partially shortened depending on the lens type.
- The EF 15mm f/2.8 Fisheye and EF 8-15mm f/4L USM Fisheye are not compatible with [Register lens aberration correction data]/[Register peripheral illumination correction data].

Introduction

Contents at a Glance

Downloading Images

Camera Settings

Remote Shooting

Preferences

Reference

Index

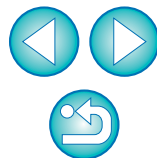



# Setting My Menu and Registering to the Camera

You can register up to six frequently used menu items as My Menu and register them to the camera, in the same way as operating from the camera.

You can register top layer items of each tab as well as all items of Custom Functions.

**1** Connect your camera and computer, and then start up EU (p.5).

**2** Click [Camera settings/Remote shooting].



→ The capture window appears.

**3** Click the [☆] button.



→ The [My Menu] appears.

Introduction

Contents at a Glance

Downloading Images

Camera Settings

Remote Shooting

Preferences

Reference

Index

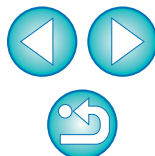

## 4 Click [My Menu settings].

### My Menu

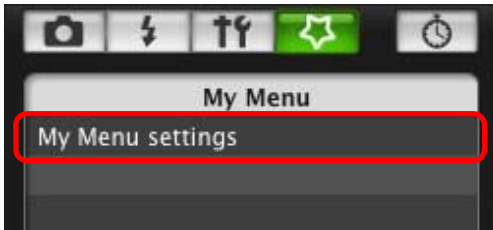

→ The [My Menu settings] window appears.

## 5 Select the item to be registered and click the [Add] button.

### My Menu settings window

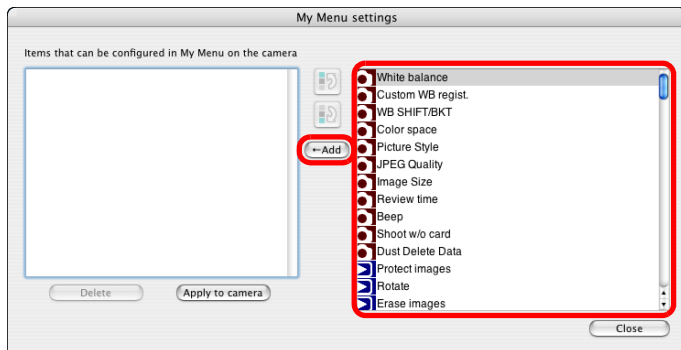

→ The selected item is added to [Items that can be configured in My Menu on the camera] on the left side of the window.

- You can register up to six items with the above procedure.
- You can change the position of an item by selecting it and then clicking the [ ] or [ ] button to move it.

## 6 Click the [Apply to camera] button.

→ The setting is applied to the camera.

Introduction

Contents at a Glance

Downloading Images

Camera Settings

Remote Shooting

Preferences

Reference

Index

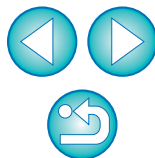

# 3 Remote Shooting by Controlling the Camera from Your Computer

From EU you can control the camera remotely, and by viewing the subject in the EU window, you can set the camera and shoot. You can also shoot by directly operating your camera even during remote shooting, or preset a time allowing the camera to shoot automatically with timer shooting.

Remote Live View Shooting .....	27
HDR (High Dynamic Range) Shooting .....	33
Remote Live View Window Functions .....	35
Focusing Manually .....	35
Focusing Using AF .....	36
Focusing Using Quick Mode .....	36
Focusing Using Live Mode .....	38
Focusing Using Face Detection Live Mode .....	39
Focusing Using Face+Tracking .....	39
Focusing Using FlexiZone-Multi .....	40
Checking the Depth of Field and Exposure .....	40
White Balance with the Remote Live View Window ..	41
White Balance for Flash Photography .....	41
Displaying an Electronic Level .....	43
Changing the Aspect Ratio .....	44
Audio Recording Setting .....	45
Audio Recording/Audio Recording Level .....	46
Wind Filter Function .....	46
Overlaid Display Function .....	47
Enlarging/Reducing an Overlay Image .....	48
Rotating an Overlay Image .....	49
Setting the Composite Ratio of an Overlay Image .....	49
Moving an Overlay Image .....	50
Displaying a Different Overlay Image .....	50
Hiding an Overlay Image .....	51

Displaying Grid Lines .....	51
Shooting by Operating the Camera .....	52
Shooting Movies .....	53
Timer-controlled Shooting .....	64
Timer Shooting .....	64
Interval Timer Shooting .....	64
Bulb Exposures .....	65
Flash Shooting .....	66
Registering Background Music to a Camera Memory Card .....	70

Introduction

Contents at a Glance

Downloading Images

Camera Settings

Remote Shooting

Preferences

Reference

Index

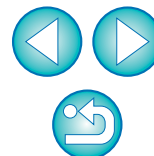

# Remote Live View Shooting



You can control your camera remotely from EU and shoot still images from your computer screen.

Also, the shot images are saved directly on your computer and you can recheck them using the linked software Digital Photo Professional (hereinafter DPP).

This function is effective for shooting large numbers of shots with fixed-framing such as for studio shooting.

## 1 Connect your camera and computer, and then turn the camera's power switch to < ON >.

→ EU starts up.

- REBELTi 500D cannot communicate with EU if the camera's Mode Dial is set to <  >. Set the Mode Dial to a mode other than <  >.

## 2 Click [Camera settings/Remote shooting].



→ The capture window appears.

Introduction

Contents at a Glance

Downloading Images

Camera Settings

Remote Shooting

Preferences

Reference

Index

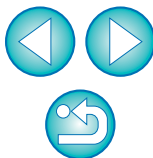

### 3 Set the camera.

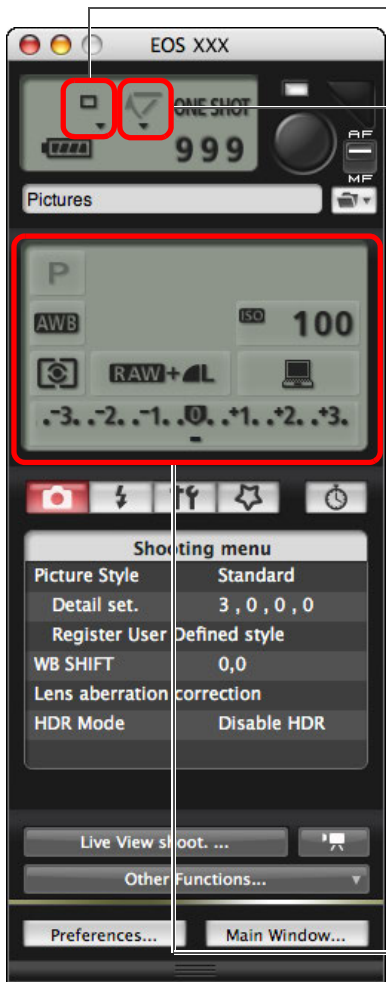

#### Drive mode setting

Click ▼ while holding down the <control> key under the setting item and select settings from the menu\*<sup>1</sup> that appears

- ( 1D X 1D Mk IV 5D Mk III
- 5D Mk II 7D 60D
- 50D REBELT4i 650D
- REBELT3i 600D REBELT2i
- 550D REBELT1i 500D
- REBELT3 1100D )

#### Mirror lockup menu display and setting

Click ▼ while holding down the <control> key under the setting item and select settings from the menu\*<sup>1</sup> that appears

- ( 1D X 1D Mk IV 5D Mk III
- 7D 60D REBELT4i
- 650D REBELT3i 600D
- REBELT2i 550D )

Double-click the setting item, and select the setting\*<sup>1</sup> \*<sup>2</sup>

\*<sup>1</sup> You can also use the scroll-wheel on your mouse to select settings for items in the settings window and menus that appear. You cannot use the scroll-wheel in the mirror lockup menu.

\*<sup>2</sup> On 1D X 1D Mk IV 5D Mk III 5D Mk II 7D 60D 50D REBELT4i 650D REBELT3i 600D REBELT2i 550D REBELT1i 500D REBELT3 1100D , you can click the Exposure level/AEB level item while holding down the <control> key and perform AEB setting using the <shift> key + scroll-wheel.

- You can also use the functions of the [Shooting menu] (p.14).
- The settings that cannot be set in the capture window can be set by operating the camera.
- On 1D X 5D Mk III REBELT4i 650D , a warning lamp blinks during the countdown for self-timer shooting and the countdown time is displayed in the area for the number of possible shots.
- Mirror lockup settings are available when the camera mode is P, Tv, Av, M, A-DEP or B.
- During mirror lockup, the mirror lockup icon blinks.
- When shooting with auto exposure on 1D X 5D Mk III REBELT4i 650D , the shutter speed or aperture blinks to indicate under-exposure or over-exposure conditions.
- When shooting with manual exposure on 1D X 5D Mk III REBELT4i 650D , the metering value is displayed in real time in the exposure level area.

Introduction

Contents at a Glance

Downloading Images

Camera Settings

Remote Shooting

Preferences

Reference

Index

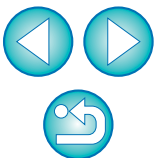

## 4 Click the [ ] button.



→ The [Set-up menu] appears.

## 5 Set the Live View function.

- Click [Live View/Movie func. set.], and click [Enable] in the [Live View shoot.] window that appears.

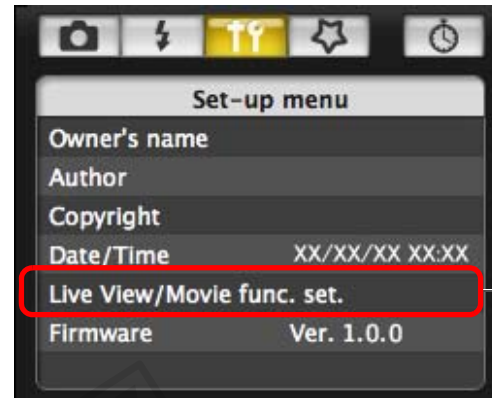





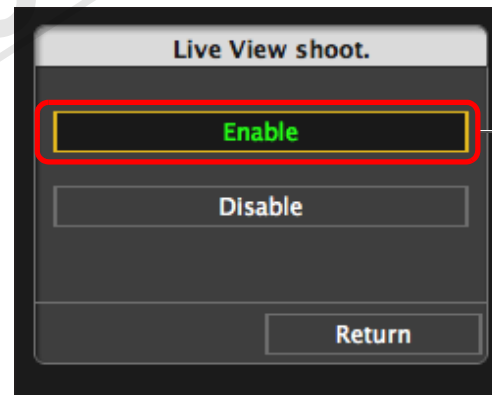



Click

### Live View shoot. window



Click

- For cameras other than         , the [Live View/Movie func. set.] window appears.  
For details on specifying settings, see the [next page](#).

Introduction

Contents at a Glance

Downloading Images

Camera Settings

Remote Shooting

Preferences

Reference

Index

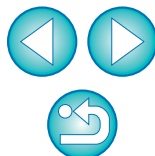

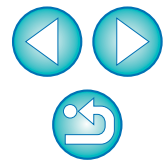

### Live View/Movie func. set. window

1D X 1D Mk IV

Select [Stills] for [LV func. setting] and a setting for [Exposure simulation], and click the [OK] button.

1D X

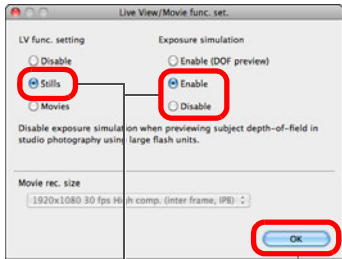

Select

Click

1D Mk IV

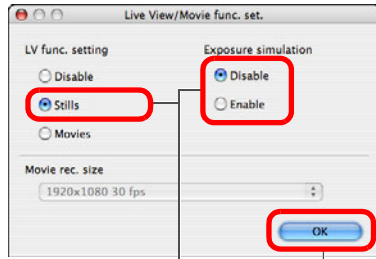

Select

Click

5D Mk II

Select [Stills only] and [Still display], and click the [OK] button.

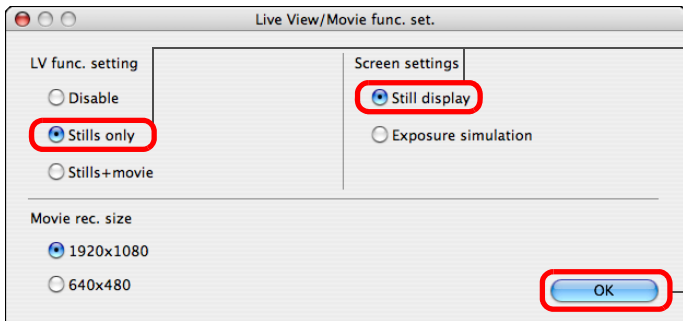

Select

Click



### Exposure simulation

Exposure simulation simulates and displays the image with a brightness close to the actual resulting image.

- Enable  
The displayed image brightness will be close to the actual brightness (exposure) of the resulting image. If you set exposure compensation, the image brightness will change accordingly.
- Disable  
The image is displayed at the standard brightness to make the Live View image easy to see. Even if you set exposure compensation, the image is displayed at the standard brightness.
- Enable (DOF preview)  
Normally, the image is displayed at the standard brightness to make the Live View image easy to see. The image will be displayed close to the actual brightness (exposure) of the resulting image only while you hold down the depth-of-field preview button.

5D Mk III 7D 60D

Select [Enable] for [LV func. setting] and the setting for [Exposure simulation], then click the [OK] button.

5D Mk III

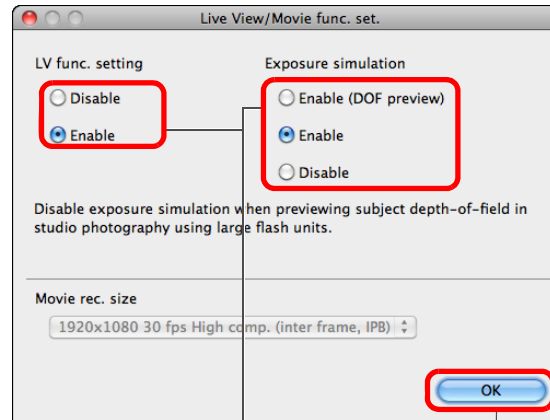

Select

Click

### 6 Click the [Live View shoot.] button.

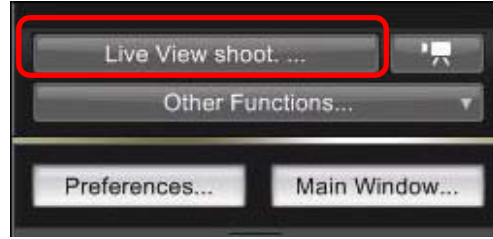

→ The [Remote Live View window] appears.



### Remote Live View window

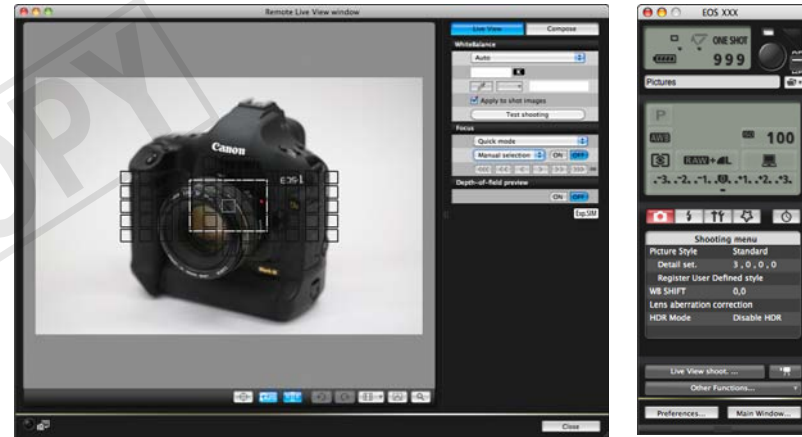

7D

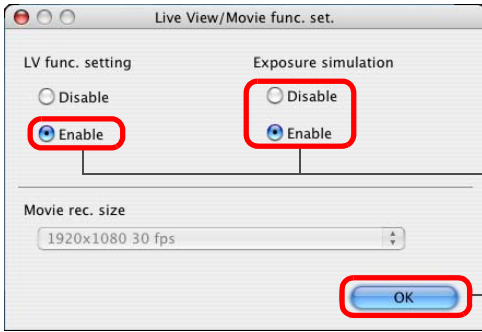

Select

Click

60D

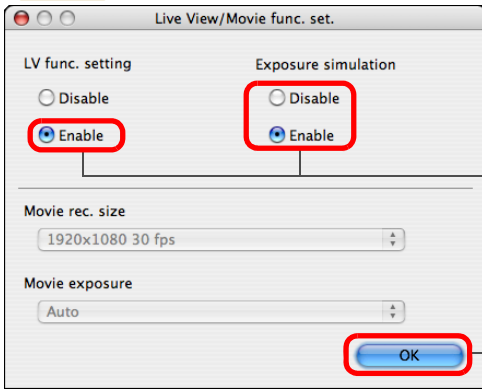

Select

Click

- REBELT4i 650D REBELT3i 600D REBELT2i 550D REBELT1i
- 500D REBELT3 1100D

Select [Enable] and click the [OK] button.

- REBELT4i 650D REBELT3i
- 600D REBELT2i 550D
- REBELT3 1100D

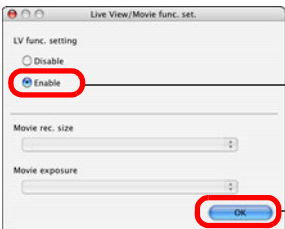

Select

Click

REBELT1i 500D

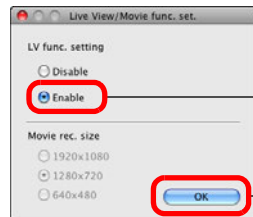

Select

Click

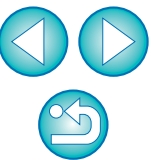



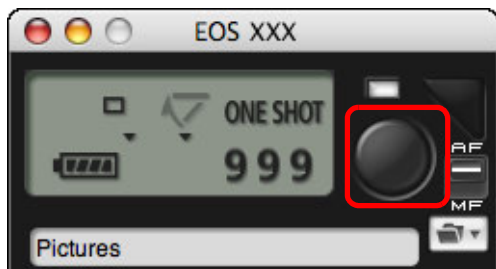

## 7 Click the [●] button to shoot.



- The shot image is transferred to your computer and displayed in the [Quick Preview] window. And then, DPP starts up automatically.
- You can quickly review the shot image in the [Quick Preview] window displayed before DPP starts up. You can also resize the [Quick Preview] window.
- You can show/hide the [Quick Preview] window by clicking the [Other Functions] button in the capture window and selecting [Quick Preview] from the menu that appears.

- ! You cannot perform RAW processing. If you connect the camera to your computer during in-camera RAW processing, the camera and computer will connect after you finish processing.
- On **60D** **REBELT4i** **650D** **REBELT3i** **600D** **REBELT3** **1100D** you cannot set [Creative Auto].

 You can also shoot using the <space> bar on the keyboard.

-  You cannot operate the camera when the [Remote Live View window] is displayed. Pressing the Live View shooting button (the camera's <SET> button on the **1D Mk IV** **1Ds Mk III** **1D Mk III** **40D** **REBELXS*i*** **450D** **REBELXS** **1000D**) will also display the Live View image on the camera's LCD monitor, allowing you to view the image while operating the camera.
- You can shoot by operating the capture window, even if the [Remote Live View window] is not displayed.
- To perform exposure simulation (p.40) with [Remote Live View window] or enable display of histograms (p.95), set your camera's Custom Function [Live View exposure simulation] to [Enable]. On **1D X** **1D Mk IV** **5D Mk III** **5D Mk II** **7D** **60D** **50D**, set [Exposure simulation] in the menu to [Enable].
- On **1D X** **1D Mk IV** **5D Mk III** **5D Mk II** **7D** **60D** **50D** **REBELT4*i*** **650D** **REBELT3*i*** **600D** **REBELT2*i*** **550D**, you can also use mirror lockup with remote shooting. (You cannot take test shots after setting mirror lockup.)
- On **1D X** **5D Mk III** **REBELT4*i*** **650D**, self-timer shooting is possible.
- With **1Ds Mk III** **1D Mk III**, mirror lockup and Silent single shooting cannot be performed in remote shooting.
- The [Test Shooting] window appears when you click the [Test shooting] button. During flash shooting, you can take a test shot under the same conditions as an actual shot, and adjust the white balance based on the shot test image (p.41).
- You can save shot images to both your computer and a memory card by checkmarking [Save also on the camera's memory card] in preferences ([Remote Shooting] window) (p.76).
- You can change the software that starts up automatically when remotely shot images are transferred to your computer from DPP to ImageBrowser EX or other software in preferences ([Linked Software] window) (p.77).
- For a list of the [Remote Live View window] functions, see p.95.
- For a list of the [Zoom View] Window functions, see p.97.

Introduction

Contents at a Glance

Downloading Images

Camera Settings

Remote Shooting

Preferences

Reference

Index

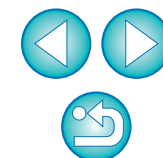

# HDR (High Dynamic Range) Shooting



You can shoot photos with a wide dynamic range where clipping in highlights and shadows has been reduced, and photos that appear like paintings. This is suited for scenes such as still-life and landscape. In HDR shooting, one shot is taken using three images shot with different exposures (negative exposure, standard exposure, positive exposure), and they are combined into a single image automatically. Shot HDR images are recorded in JPEG quality.

\* HDR stands for High Dynamic Range.

## 1 Set to HDR.

- Select [HDR Mode] in the [Shooting menu], and in the dialog box that appears, specify the required settings and click the [OK] button.

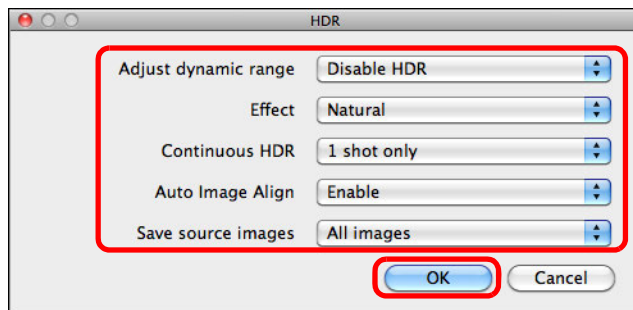
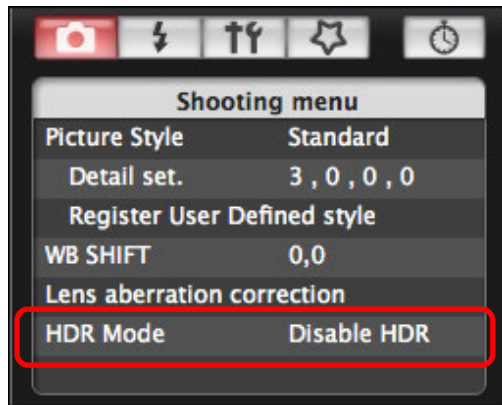

- [Adjust dynamic range]: Sets the range of adjustment for dynamic range. Select from [Disable HDR], [Auto], [ $\pm 1$ ], [ $\pm 2$ ], and [ $\pm 3$ ]. When selecting [Auto], the range of adjustment will be set automatically depending on the image's overall tonal range. The higher the number, the wider the dynamic range will be.
- [Effect]: Selects the finishing effect. For specific finishing effects, refer to the pages about HDR (High Dynamic Range) shooting in the Instruction Manual provided with your camera.
- [Continuous HDR]: If [1 shot only] is selected, HDR shooting is cancelled automatically after you finish shooting. If you select [Every shot], HDR shooting is continued until you select [Disable HDR] in [Adjust dynamic range].
- [Save source images]: To save the three shot images and the completed HDR image, select [All images]. To save only the completed HDR image, select [HDR image only].

Introduction

Contents at a Glance

Downloading Images

Camera Settings

Remote Shooting

Preferences

Reference

Index

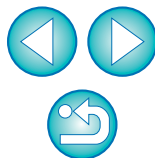

## 2 Take a shot.

- ⚠ The HDR mode cannot be set if you use any of the following functions: AEB, white balance bracketing, multiple exposures, flash exposure, bulb exposure, or movie shooting.
- HDR shooting of a moving subject is not recommended because the movement of the subject will appear as afterimages in the merged image. HDR shooting is recommended for still subjects.
- In HDR shooting, 3 images are captured with different shutter speeds set automatically. Therefore, even in Tv and M shooting modes, the shutter speed will be shifted based on the shutter speed set.
- To prevent camera shake, the ISO speed may be set higher than usual.
- Auto image alignment may not work properly with repetitive patterns (lattice, stripes, etc.) or flat, single-tone images.
- The color gradation of the sky or white walls may not be reproduced correctly. Irregular colors or noise may appear.
- With HDR shooting, the three images will be merged after you take a picture. Therefore, it will take a longer time to record the HDR image than with normal shooting. During the merging of the images, "BUSY" will be displayed on the camera and you cannot take another picture until the merging is completed.

- ⚠ • Using a tripod is recommended. For handheld shooting, using a fast shutter speed is recommended.
- If [Auto Image Align] is set to [Enable] and the HDR picture is shot handheld, the edges of the photos will be cropped, lowering the resolution slightly. Also, if the images cannot be aligned properly due to camera shake, etc., auto image alignment may not take effect. Note that when shooting with excessively bright or dark exposure settings, auto image alignment may not work properly.
- If you perform handheld HDR shooting while [Auto Image Align] is set to [Disable], the 3 images may not be properly aligned and the HDR effect may be minimal.
- HDR shooting under fluorescent or LED lighting may result in unnatural color reproduction of the illuminated areas.
- In HDR mode, the options dimmed in the menu cannot be set. When you set HDR mode, the Auto Lighting Optimizer will be set automatically to [Disable]. It will revert to the original setting when you cancel the HDR mode.

- 📄 • If you perform HDR shooting with the image quality set to RAW, HDR images are recorded in [L] quality.
- If you perform HDR shooting with the image quality set to RAW+JPEG, HDR images are recorded in JPEG quality.

Introduction

Contents at a Glance

Downloading Images

Camera Settings

Remote Shooting

Preferences

Reference

Index

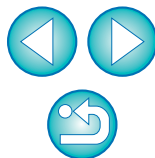

# Remote Live View Window Functions

These pages explain the functions available in the [Remote Live View window], including checking the camera settings and focusing while viewing your subject on the computer screen.

See also the list of [Remote Live View window] functions at the end of this manual (p.95, p.96).

## Focusing Manually

You can focus manually while viewing the enlarged image in the [Remote Live View window].

1 Set the lens's focus mode switch to < AF >.

2 Drag [ ] to the section you want to enlarge.

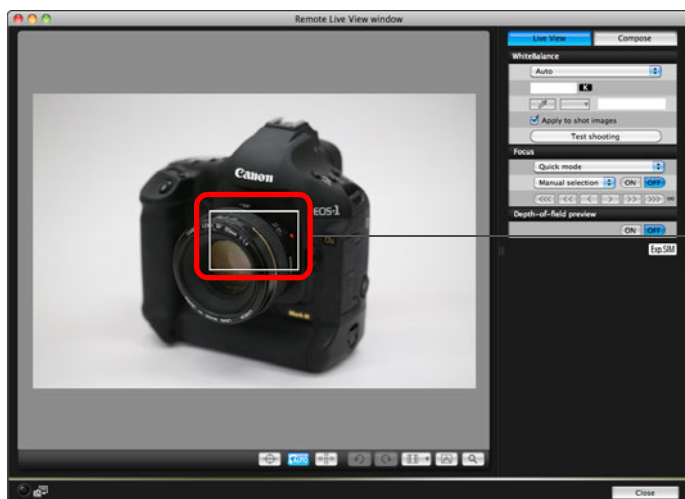

3 Click the [ ] button.



→ The section you selected in step 1 is displayed enlarged at 100% (actual pixel size) in the [Zoom View] window.



Zoom View window

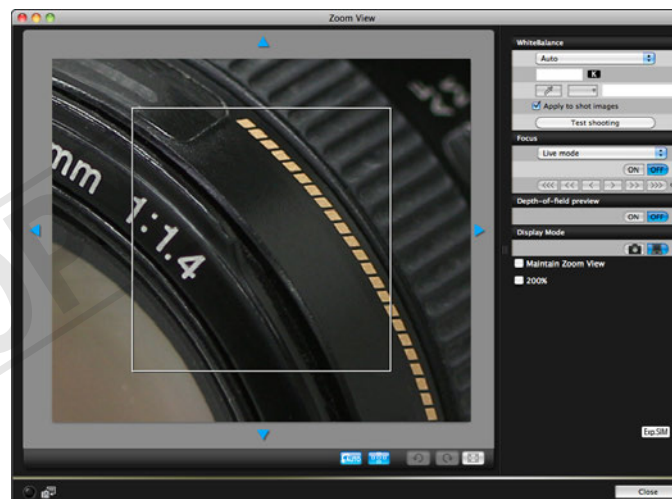

- To move the display position in the [Zoom View] window, click on [ ], [ ], [ ], [ ]. You can also move the display position by dragging the window.
- You can checkmark [Maintain Zoom View] to maintain display of the [Zoom View] window.
- You can also double-click the section you want to enlarge in step 1 to display an enlarged view at 100% (actual pixel size) in the [Zoom View] window.
- Double-click an image in the [Zoom View] window to return to the [Remote Live View window].
- You can checkmark [200%] to view the section enlarged to 200%.

Introduction

Contents at a Glance

Downloading Images

Camera Settings

Remote Shooting

Preferences

Reference

Index

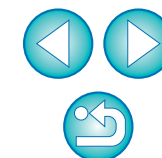

# 4 Adjust the focus.

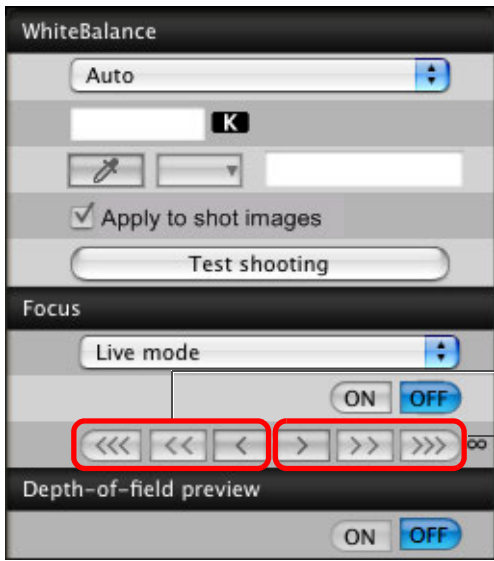

Closer  
Further away

- [ <<<< ], [ >>>> ]: Adjustment Large amount
  - [ << ], [ >> ]: Adjustment Medium amount
  - [ < ], [ > ]: Adjustment Small amount
- The [Remote Live View window] changes in real time according to the focus position adjustment.

## Focusing Using AF



In Quick, Live, Face Detection Live, and other AF modes, images can be focused automatically in the same way as on the camera itself.

## Focusing Using Quick Mode



1 Select [Quick mode] from the list box.

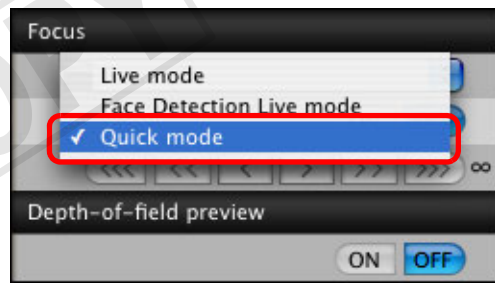

- The AF points appear.
- You can switch between showing and hiding the AF points by clicking the [ <img alt="AF points icon" data-bbox="585 675 615 705"/> ] button.

2 Select an AF point selection method from the list box.

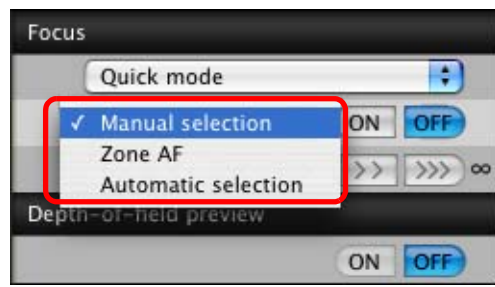

- Selectable items differ depending on the camera settings.

You can also focus using a key operation on the keyboard.

Adjustment	Closer	Further away
Large amount	< I >	< O >
Medium amount	< K >	< L >
Small amount	< < >	< > >

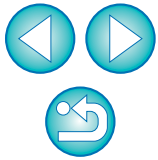

### 3 Click the AF point in the position where you want to focus.

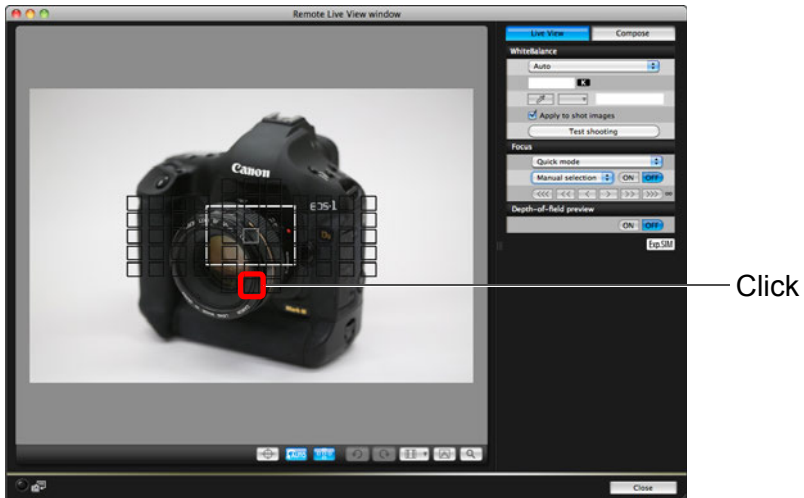

- If [Automatic selection] is selected in step 2, all the AF points are automatically selected.
- If [Manual selection] is selected in step 2, only the selectable AF points are displayed.

### 4 Click the [ON] button.

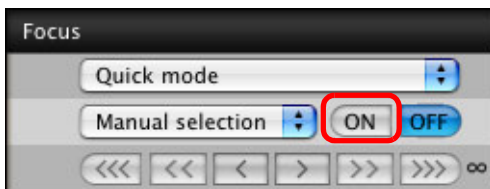

- AF is executed.
- When focus is achieved, the camera makes a beeping sound and the AF point color changes.

**!** On **1D X** **5D Mk III** **7D**, cancel the AF point registration function on the camera if AF points have been registered. When the camera's AF points are registered, focusing with AF in the [Remote Live View window] may not be performed properly.

- Double-clicking an AF point also performs AF.
- To cancel AF operation, click the [OFF] button.

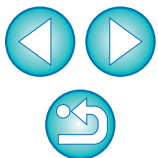

## Focusing Using Live Mode



- 1D X 1D Mk IV 5D Mk III 5D Mk II 7D 60D 50D  
REBELT4i 650D REBELT3i 600D REBELT2i 550D REBELT1i  
500D REBELT3 1100D

1 Select [Live mode] or [FlexiZone – Single] from the list box.

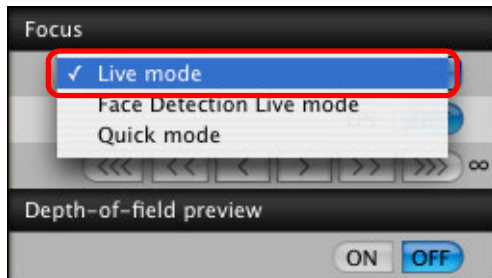

- The AF point appears.
- On REBELT4i 650D, you can set continuous AF to on/off with the [Continuous AF] box. When shooting movies, the [Continuous AF] box changes to the [Movie servo AF] on/off box.
- You can switch between showing and hiding the AF point by clicking the [ ] button.

2 Drag the enlargement display frame to move it to the position where you want to focus.

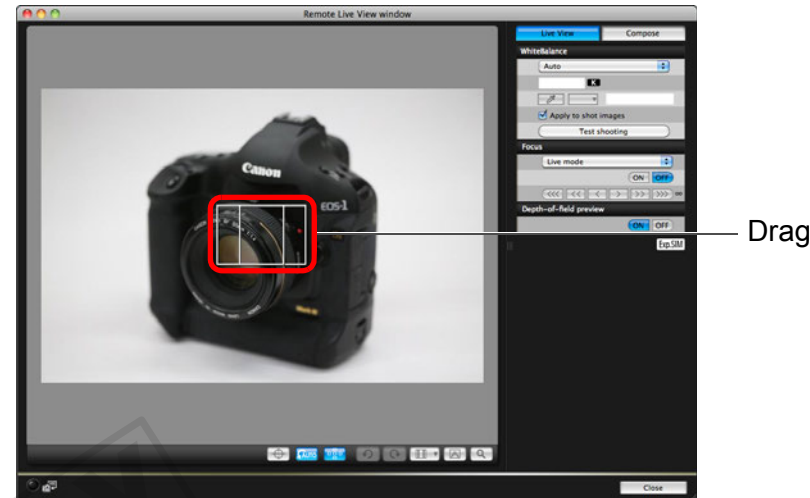

3 Click the [ON] button.

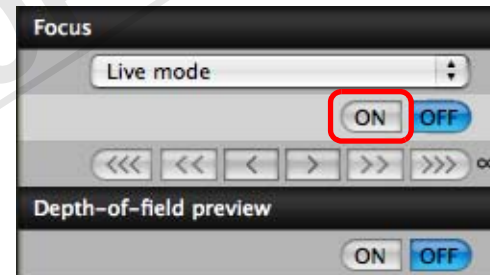

- AF is executed.
- When focus is achieved, the camera makes a beeping sound and the AF point turns green.
- If focus is not achieved, the AF point turns red.

Introduction

Contents at a Glance

Downloading Images

Camera Settings

Remote Shooting

Preferences

Reference

Index

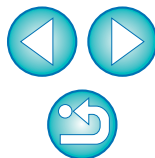



## Focusing Using Face Detection Live Mode

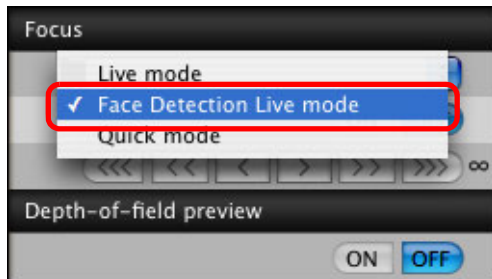

1D X 1D Mk IV 5D Mk III 5D Mk II 7D 60D 50D  
REBELT3i 600D REBELT2i 550D REBELT1i 500D REBELT3  
1100D

### 1 Select [Face Detection Live mode] from the list box.



- When a face is detected, an AF point appears.
- When there is a face other than the face detected in the scene, a new AF point appears if you move the cursor to the position of the other face. The AF point is selected by clicking that position.
- You can switch between showing and hiding the AF point by clicking the [  ] button.

### 2 Click the [ON] button.

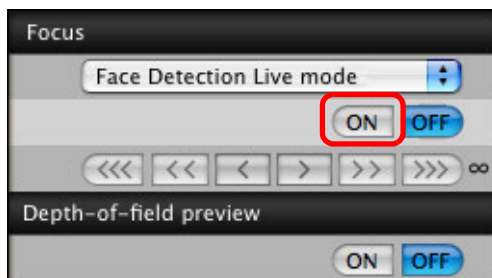

- AF is executed.
- When focus is achieved, the camera makes a beeping sound and the AF point turns green.
- If focus is not achieved, the AF point turns red.
- If the camera cannot detect a face, the AF point is fixed to the center to focus.

## Focusing Using Face+Tracking



REBELT4i 650D

### 1 Select [Face detection + Tracking AF] from the [Focus] list box.

- When a face is detected, an AF point appears.
- The AF point also tracks the face if the face moves.
- When there is a face other than the face detected in the scene, a new AF point appears if you move the cursor to the position of the other face. The AF point is selected by clicking that position.
- You can set continuous AF to on/off with the [Continuous AF] box. When shooting movies, the [Continuous AF] box changes to the [Movie servo AF] on/off box.
- You can switch between showing and hiding the AF point by clicking the [  ] button.

### 2 Click the [ON] button on the [Focus] list box.

- AF is executed.
- When focus is achieved, the camera makes a beeping sound and the AF point turns green.
- If focus is not achieved, the AF point turns red.
- If a face is not detected, the mode changes to [FlexiZone-Multi] (p.40).

Introduction

Contents at a Glance

Downloading Images

Camera Settings

Remote Shooting

Preferences

Reference

Index

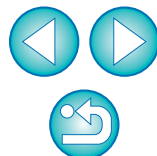



# Focusing Using FlexiZone-Multi



This AF mode allows focus to be easily achieved on moving subjects. You can adjust focus over a wide area, and also divide the area into zones for focusing.

## 1 Select [FlexiZone-Multi] from the [Focus] list box.

- An AF point appears.
- You can click in the window to select an AF zone. To cancel a selected zone, select [FlexiZone-Multi] again from the [Focus] list box.
- You can set continuous AF to on/off with the [Continuous AF] box. When shooting movies, the [Continuous AF] box changes to the [Movie servo AF] on/off box.
- You can switch between showing and hiding the AF point by clicking the [ ] button.

## 2 Click the [ON] button on the [Focus] list box.

- AF is executed.
- When focus is achieved, the camera makes a beeping sound and the AF point turns green.
- If focus is not achieved, the AF point turns red.
- The number of AF points and zones depend on the selected aspect ratio and the image being shot (still image/movie).

# Checking the Depth of Field and Exposure

You can check the depth of field and exposure in the [Remote Live View window].

Click the [ON] button.



→ The aperture value (exposure simulation) is set in the capture window (p.91).

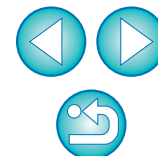

## White Balance with the Remote Live View Window

You can change the white balance of an image in the [Remote Live View window] and register the changed white balance in the camera.

### 1 Select the white balance to apply to the image.



→ The selected white balance is applied to the image displayed in real time and you can check it in the [Remote Live View window].

### 2 Checkmark [Apply to shot images].

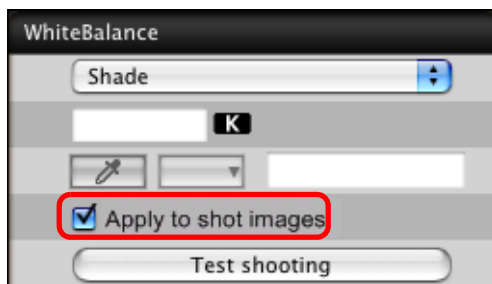

→ The selected white balance is registered in the camera as a personal white balance and applied to images that will be taken.

## White Balance for Flash Photography

When taking flash shots where the subject is illuminated instantaneously, you can take a test shot under the same conditions as an actual shot, and adjust the white balance in the [Test shooting] window based on the shot test image. Also, you can take a test shot even when flash is not used.

You can perform the same operation by clicking the [Test shooting] button in the [Remote Live View window].

### 1 Click the [Other Functions] button and select [Test shooting] from the menu that appears.

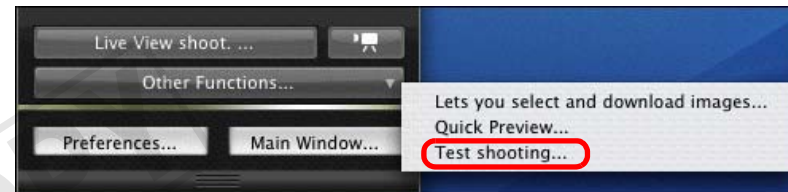

→ The shot image is displayed in the [Test shooting] window.

#### Test shooting window

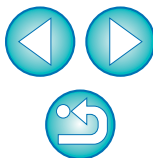
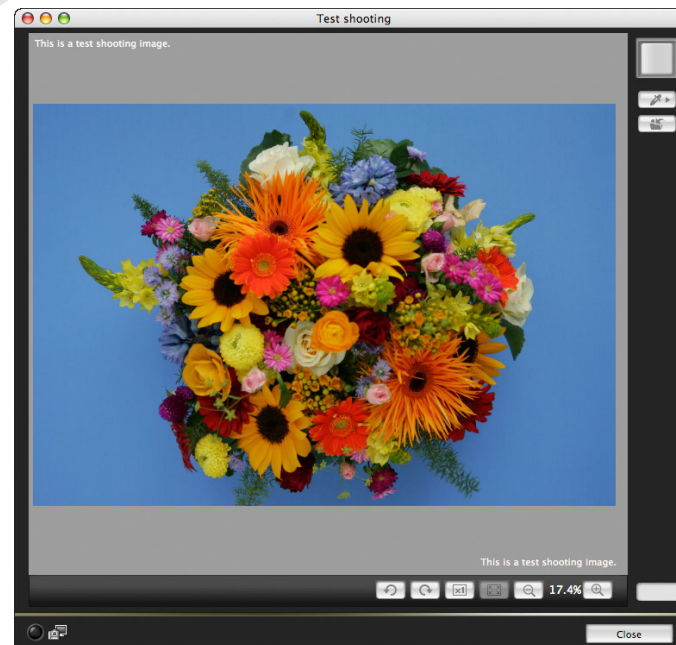

## 2 Click the [ ] button.

→ The click white balance window appears.

### Click white balance window

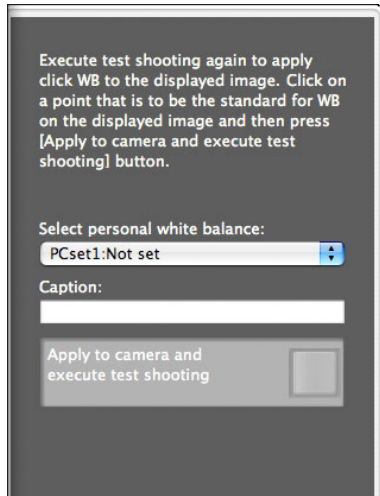

## 3 Click on a point that is to be the standard for white.

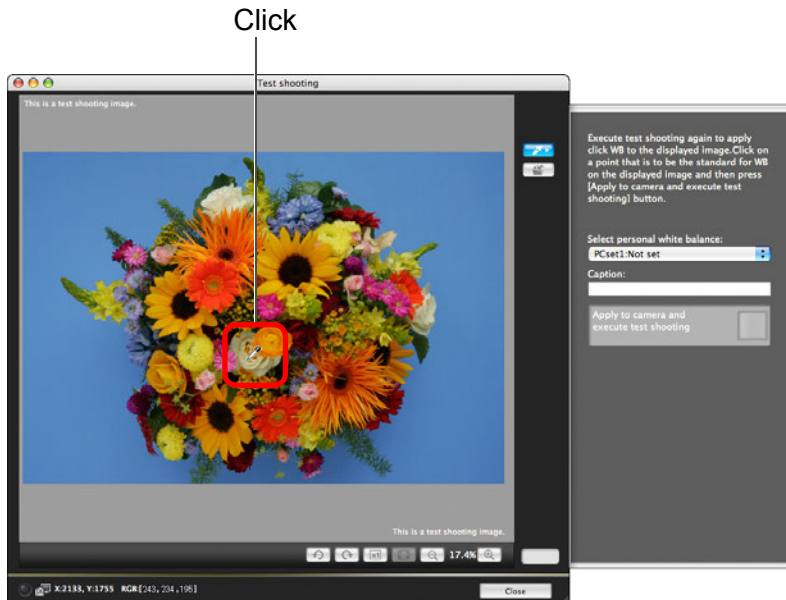

## 4 Click the [Apply to camera and execute test shooting] button.

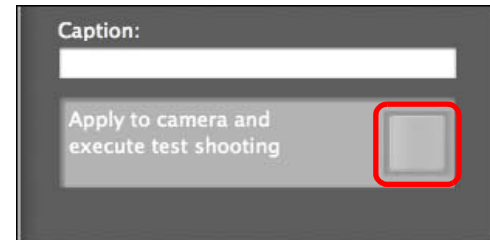

- A shot will be taken again using the part of the image in step 3 clicked as the standard for white and the shot image is displayed in the [Test shooting] window.
- The test image will not be saved. To save the test image, click the [  ] button.
- To close the [Test shooting] window, click the [Close] button.

- You can perform the following operations in the [Test Shooting] window using keyboard controls.
  - Test shooting: <option> + <space>
  - 50% image display: <⌘> + <1>
  - 100% image display: <⌘> + <2>
  - 200% image display: <⌘> + <3>
  - Match image size to window: <⌘> + <4>
- On **1D X** **1D Mk IV** **5D Mk III** **5D Mk II** **7D** **60D** **REBEL4i** **650D** **REBEL3i** **600D** **REBEL2i** **550D** **REBEL3** **1100D**, you can link flash setting/test shooting/white balance adjustment by simultaneously displaying the [Flash function settings] window (p.68) and the [Test Shooting] window.
- For a list of the [Test shooting] window functions, see p.98.

Introduction

Contents at a Glance

Downloading Images

Camera Settings

Remote Shooting

Preferences

Reference

Index

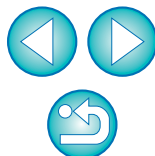

## Displaying an Electronic Level

 1D X 5D Mk III

You can display an electronic level in the [Remote Live View window] to check the tilt of the camera.

1 Click the [  ] button in the [Remote Live View window].



→ An electronic level is displayed in the [Remote Live View window].

2 Check the tilt of the camera.

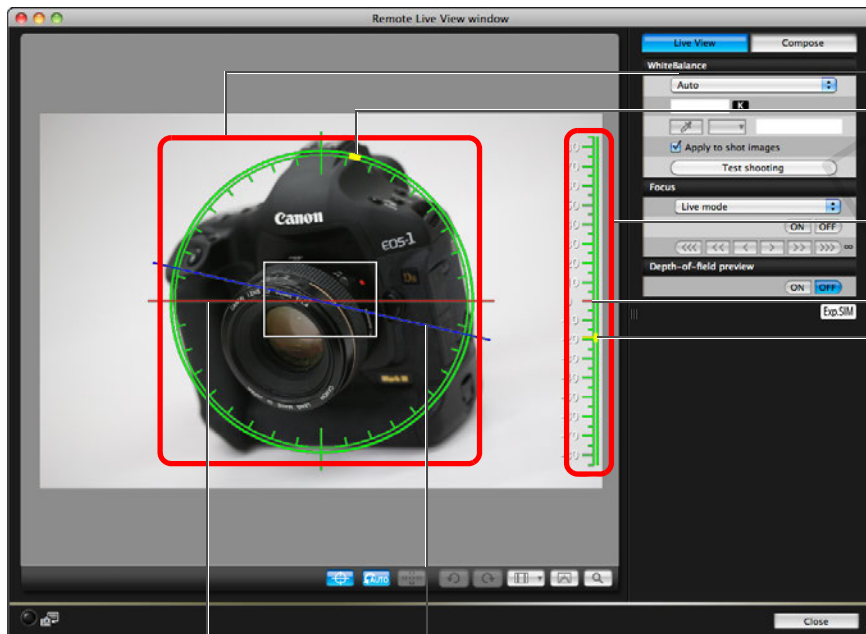

Horizontal reference

Camera's horizontal position

Horizontal level

Position of camera top

Vertical level

Vertical reference

Camera's vertical position

\* One horizontal increment is equal to  $10^\circ$ , and one vertical increment is equal to  $5^\circ$ .

- To adjust horizontal tilt, move the camera so the camera's horizontal position and the horizontal reference match.
- To adjust vertical tilt, move the camera so the camera's vertical position and the vertical reference match.
- To hide the level, click the [  ] button again.



- During movie shooting, the electronic level will not be displayed.
- Even when tilt is corrected, there may be a margin of error of approx.  $\pm 1^\circ$ .
- If the camera is very tilted, the electronic level's margin of error will be bigger.

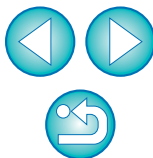

## Changing the Aspect Ratio



As with the camera's Live View function, it is possible to shoot with a feeling similar to film-type medium-format/large-format cameras such as 6 x 6 cm, 6 x 4.5 cm and 4 x 5 inches. Depending on the connected camera, there are the following differences.



For a RAW image, aspect ratio information is only attached with the shot image, and the image is not trimmed. For a JPEG image, the image is trimmed.



For both RAW and JPEG images, aspect ratio information is only attached with the shot image, and the image is not trimmed.





You can select the two following modes.

[Add aspect ratio information]: JPEG images shot in this mode are trimmed.

[Add cropping information]: Aspect ratio information is only attached, and the JPEG images shot are not trimmed.

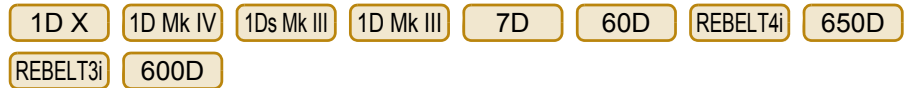
With either mode, RAW images will only have aspect ratio information attached to them, and they will not be trimmed.







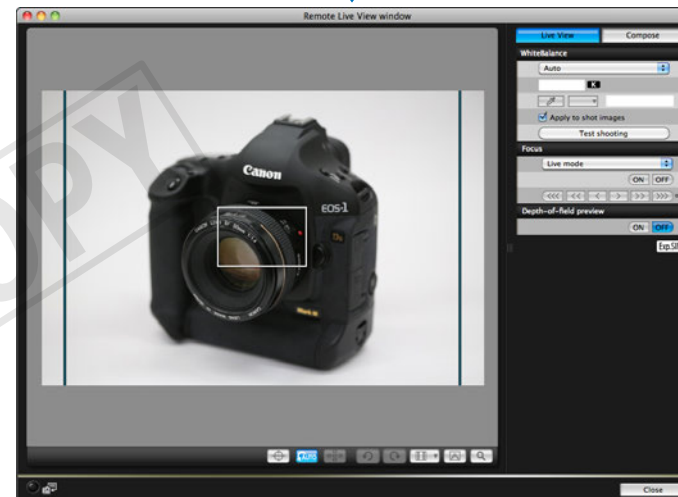

1 Click the [  ] button and select the aspect ratio.



→ In the [Remote Live View window], the vertical lines of the aspect ratio you selected are displayed.



2 Move the camera and compose your picture.

- To revert the aspect ratio to as it is normally, click the [  ] button. For      , select the original aspect ratio; for other cameras, select [Off].

Introduction

Contents at a Glance

Downloading Images

Camera Settings

Remote Shooting

Preferences

Reference

Index

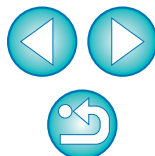

1 Click the [  ] button.



→ The [Specify Aspect Ratio/Cropping Info] dialog box appears.

2 Set [Add aspect ratio information] or [Add cropping information].

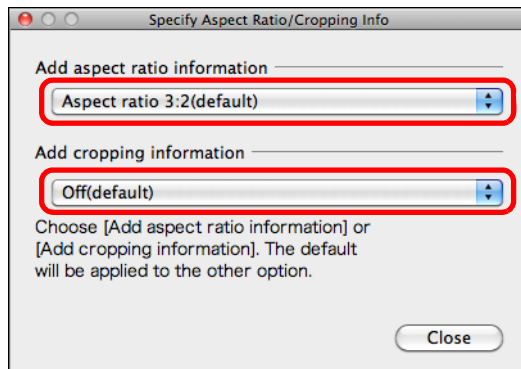

- [Add aspect ratio information] mode trims the JPEG images shot.
- [Add cropping information] mode only attaches aspect ratio information to the JPEG images shot without trimming them.
- With either [Add aspect ratio information] or [Add cropping information] selected, RAW images will only have aspect ratio information attached to the shot images, and they will not be trimmed.
- Only either one of [Add aspect ratio information] and [Add cropping information] can be set. When one mode is set, the other mode will be set to its default automatically.
- Clicking the [Close] button completes the setting.

3 Move the camera and compose your picture.

## Audio Recording Setting



You can set the audio recording level when shooting movies in Remote Live View shooting.

This function can be set only when the camera is in P, Tv, Av, M, or B shooting mode. You should also refer to the page related to “Setting the Sound Recording” in your camera’s Instruction Manual.

1 Click the [Settings] button in the audio recording area of the [Remote Live View window].

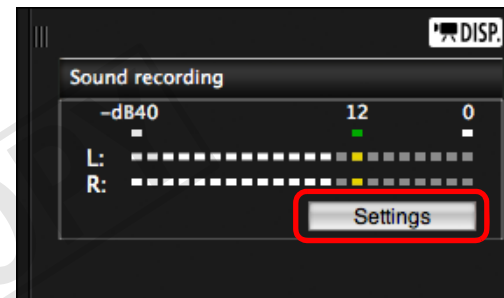

→ The [Recording settings] window appears.

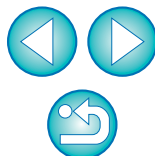

## 2 Specify settings.

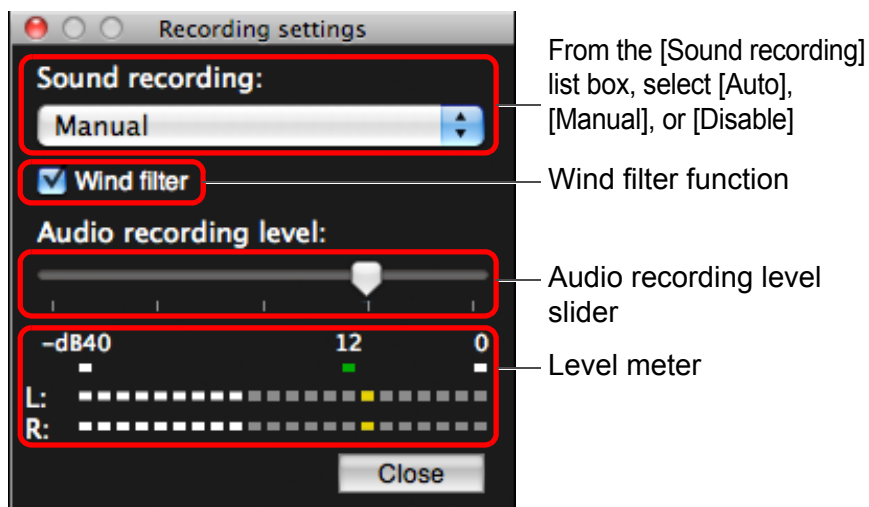

- Select [Auto], [Manual], or [Disable] from the list box.
- When setting is completed, click the [Close] button to close the [Recording settings] window.
- An attenuator settings box appears when REBELT4i 650D is connected. In conditions with much loud sound, sound cracking may occur even when shooting with [Sound recording] set to [Auto] or [Manual]. If there is sound cracking, it is recommended that you checkmark the attenuator function box to enable the attenuator function.

## Audio Recording/Audio Recording Level

- [Auto]: The audio recording level is adjusted automatically according to the volume of the sound. When [Auto] is selected, you can only set the Wind filter function.
- [Manual]: Function for advanced users. You can adjust the audio recording level as desired.  
Drag the audio recording level slider while checking the level meter to adjust the audio recording level. When the volume is loud, refer to the peak hold function (approx. 3 seconds) while adjusting so that the right side of “12” on the level meter (-12 dB) lights intermittently. Exceeding “0” results in sound cracking.
- [Disable]: Sound is not recorded.

## Wind Filter Function

When you want to reduce the sound of the wind recorded while shooting outdoors, checkmark the Wind filter function box to enable the Wind filter function. It will function only when using a built-in microphone. However, when enabled, low bass sounds are also partially reduced, and it is recommended that you remove the check mark from this box in locations with no wind, to disable the Wind filter function.

Introduction

Contents at a Glance

Downloading Images

Camera Settings

Remote Shooting

Preferences

Reference

Index

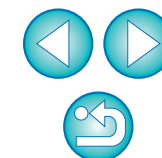

## Overlaid Display Function

An image saved in your computer can be overlaid on top of the image displayed in the [Remote Live View window]. As this function allows you to accurately align angles, it is useful when shooting several images at the same angle, such as when shooting product photos. Images loaded from your computer are only displayed, and are not included in the shot.

- 1 Select the [Compose] tab sheet in the [Remote Live View window] and click the [Open] button in [Overlay].

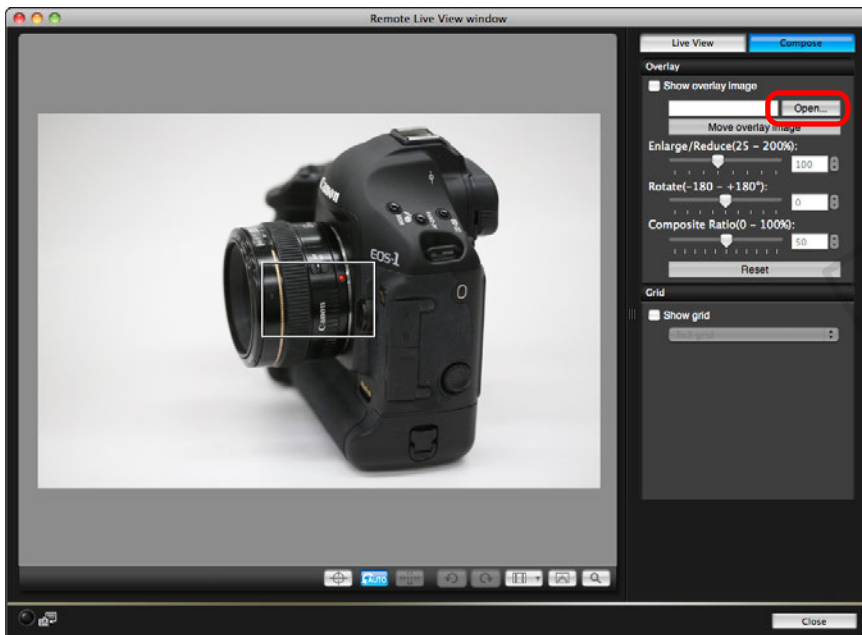

→ The [Open] dialog box appears.

- 2 Select the image you want to display as an overlay and click the [Open] button.

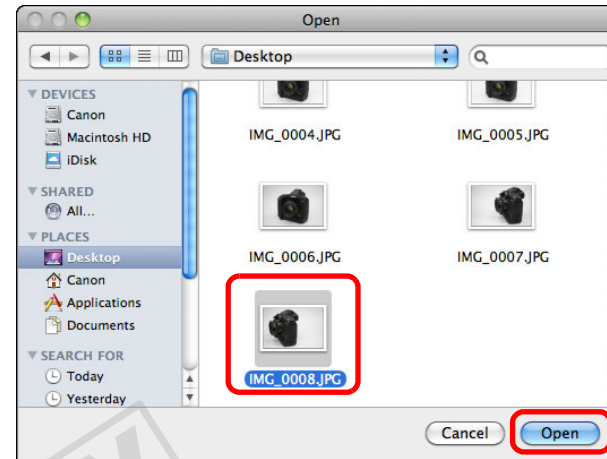

- The [Open] dialog box appears.
- RAW\*, JPEG, TIFF, BMP (bitmap), and GIF images can be displayed as an overlay.
  - \* Only RAW images with the extension “.CR2” shot with a Canon camera can be displayed as an overlay.
  - Images that have been adjusted with Digital Photo Professional are also displayed in the condition when they were shot.
- Even with supported image file types, the display of the image as an overlay may not be possible.
- [Show overlay image] is checkmarked, and the selected image is displayed as an overlay in the [Remote Live View window].

Introduction

Contents at a Glance

Downloading Images

Camera Settings

Remote Shooting

Preferences

Reference

Index

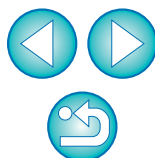



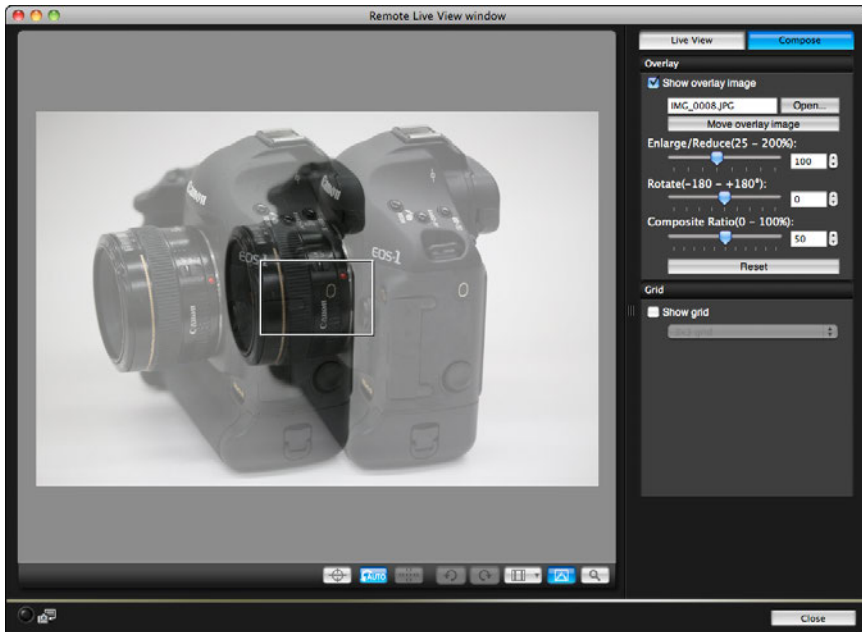

- An overlaid image (the overlay image) can be displayed enlarged/reduced, rotated, or with its composite ratio adjusted (p.49).

### 3 Move the camera and subject to compose your picture.

- You cannot use the Overlaid Display function in the [Zoom View] window.

## Enlarging/Reducing an Overlay Image

An image displayed as an overlay (the overlay image) can be enlarged/reduced from 25 to 200%. Use the [Enlarge/Reduce] slider to set the enlargement or reduction.

Drag the [Enlarge/Reduce] slider left or right.

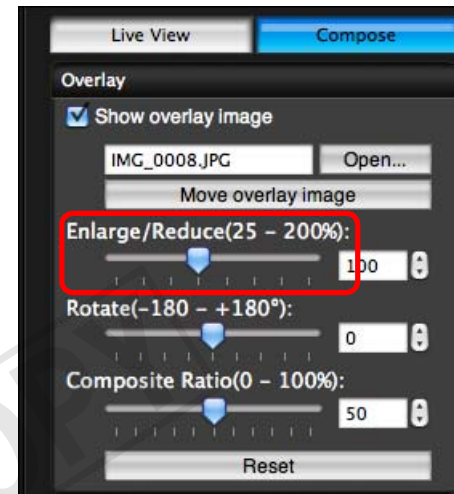

- The enlargement/reduction set with the [Enlarge/Reduce] slider is applied to the overlaid display.
- You can also set the enlargement/reduction by entering a value directly.
- You can also move the cursor over the slider, click, and then press the <<> or <>> key on the keyboard or use the scroll-wheel on your mouse to set the enlargement/reduction.
- Clicking the [Reset] button resets the image to its default state.

Introduction

Contents at a Glance

Downloading Images

Camera Settings

Remote Shooting

Preferences

Reference

Index

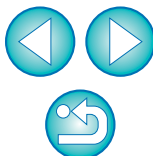

## Rotating an Overlay Image

An image displayed as an overlay (the overlay image) can be rotated from  $-180^\circ$  to  $+180^\circ$ . Use the [Rotate] slider to set the rotation.

Drag the [Rotate] slider left or right to set.

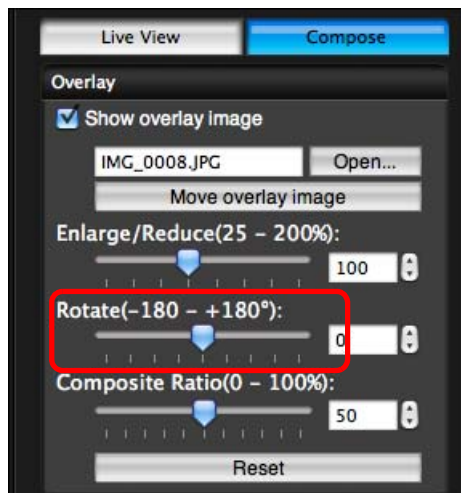

- The rotated angle set with the [Rotate] slider is applied to the overlaid display.
- You can also set the rotated angle by entering a value directly.
- You can also move the cursor over the slider, click, and then press the <<-> or <->> key on the keyboard or use the scroll-wheel on your mouse to set the rotated angle.
- Clicking the [Reset] button resets the image to its default state.

## Setting the Composite Ratio of an Overlay Image

The composite ratio (transparency) of an image displayed as an overlay (the overlay image) can be set from 0 to 100%. Use the [Composite Ratio] slider to set the composite ratio.

Drag the [Composite Ratio] slider left or right to set.

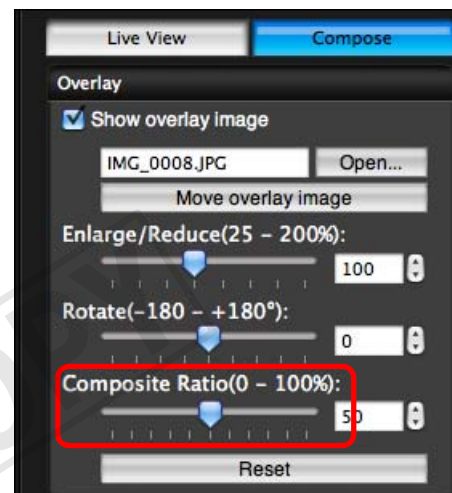

- The composite ratio set with the [Composite Ratio] slider is applied to the overlaid display.
- You can also set the composite ratio by entering a value directly.
- You can also move the cursor over the slider, click, and then press the <<-> or <->> key on the keyboard or use the scroll-wheel on your mouse to set the composite ratio.
- Clicking the [Reset] button resets the image to its default state.

Introduction

Contents at a Glance

Downloading Images

Camera Settings

Remote Shooting

Preferences

Reference

Index

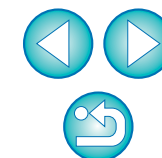

## Moving an Overlay Image

An image displayed as an overlay (the overlay image) in the [Remote Live View window] can be moved to a new position. You can also use the cursor of your mouse to enlarge/reduce or rotate the image.

### 1 Click the [Move overlay image] button.

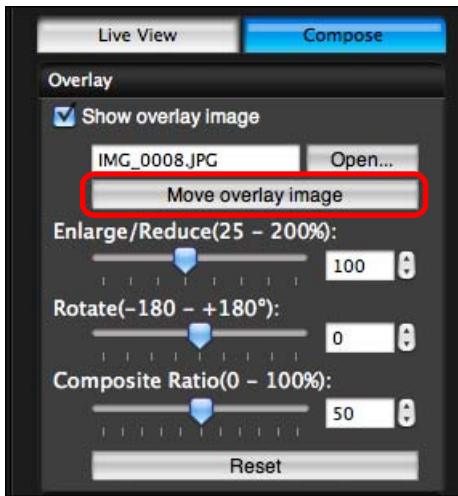

### 2 Drag the cursor of your mouse over the overlay image.

- The overlay image is moved to a new position.
- You can drag the cursor of your mouse in the [Remote Live View window] in the area outside the overlay image to rotate it.
- You can drag the cursor of your mouse in the corners of the overlay image to enlarge or reduce it.
- Clicking the [Reset] button resets the image to its default state.

## Displaying a Different Overlay Image

An image displayed as an overlay (the overlay image) can be changed to another image.

### 1 Click the [Open] button in [Overlay].

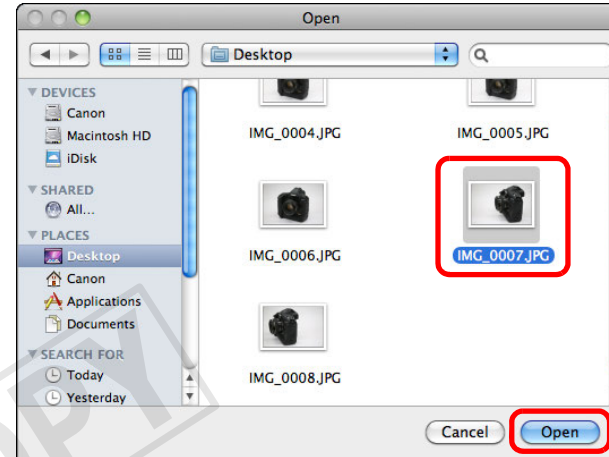

→ The [Open] dialog box appears.

### 2 Select the image you want to switch to in the [Open] dialog box and click the [Open] button.

→ The image that was displayed changes to the selected image.

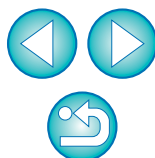

## Hiding an Overlay Image

Hide an image displayed as an overlay (the overlay image).

### 1 Remove the check mark from [Show overlay image].

→ The overlay image is hidden.

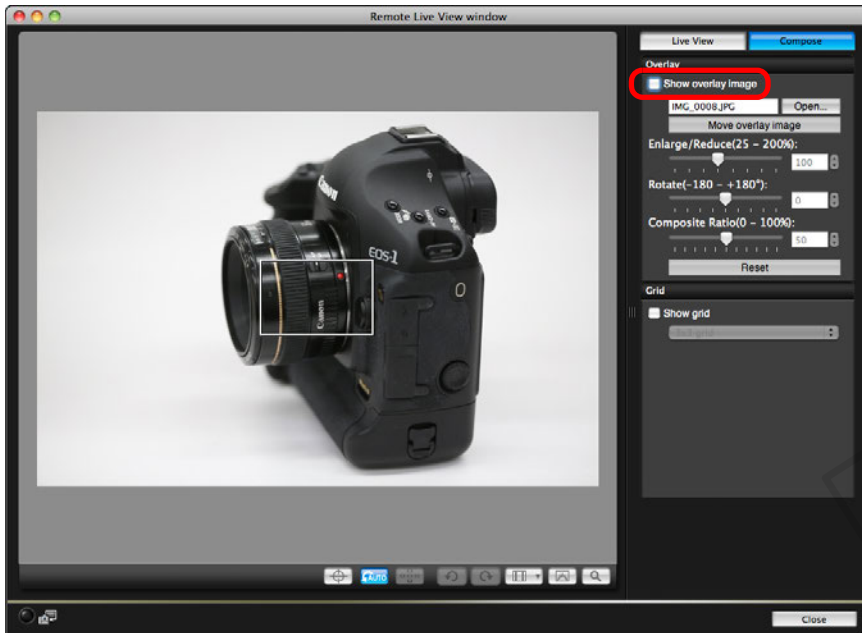

- Checkmarking [Show overlay image] redisplay the overlay image.

## Displaying Grid Lines

You can display grid lines in the [Remote Live View window] in the same way as the camera's Live View function, to check the camera's horizontal/vertical alignment.

### 1 Select the [Compose] tab sheet and checkmark [Show grid] in [Grid].

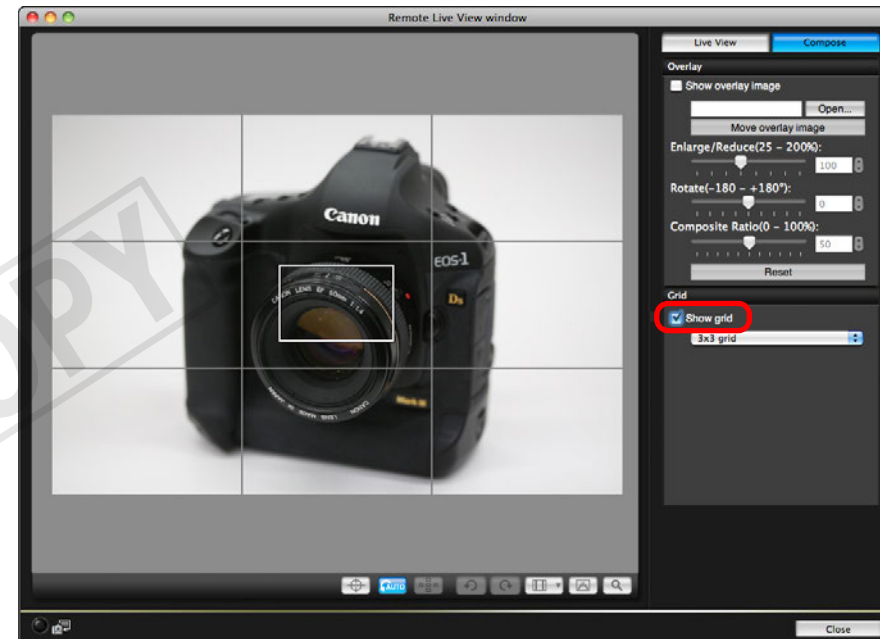

→ Grid lines are displayed in the [Remote Live View window].

Introduction

Contents at a Glance

Downloading Images

Camera Settings

Remote Shooting

Preferences

Reference

Index

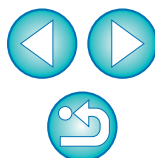

## 2 Select a display method for the grid lines from the [Grid] list box.

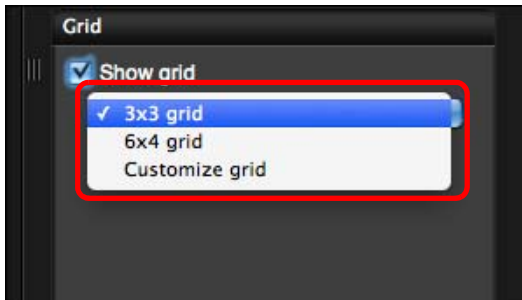

- By selecting [Customize grid], you can set the following items.
  - Number of grid blocks vertically and horizontally (2-90)
  - Grid line thickness (1-10)
  - Grid color
  - Show/hide diagonal lines

## 3 Move the camera to check its horizontal/vertical alignment.

- To hide the grid lines, remove the check mark from [Show grid].

# Shooting by Operating the Camera

Even when remote shooting is set, you can still operate the camera and shoot – as when shooting with only the camera. Also, since the shot images are saved to your computer's hard disk, you can shoot large quantities without having to worry about the capacity of the memory card.

## 1 Display the capture window (p.27).

## 2 Press the camera's shutter button and take a shot.

→ The shot images are transferred to the computer, DPP starts up automatically, and the shot images are displayed.

COPY

When the [Remote Live View window] is displayed, the camera cannot be operated. Press the Live View shooting button (the camera's <SET> button on the **1D Mk IV** **1Ds Mk III** **1D Mk III** **40D** **REBELXS<sub>i</sub>** **450D** **REBELXS** **1000D** ), to display the Live View image on the camera's LCD monitor and operate the camera.

Introduction

Contents at a Glance

Downloading Images

Camera Settings

Remote Shooting

Preferences

Reference

Index

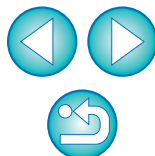

# Shooting Movies



- 1D X
- 1D Mk IV
- 5D Mk III
- 5D Mk II
- 7D
- 60D
- REBELT4i
- 650D
- REBELT3i
- 600D
- REBELT2i
- 550D
- REBELT1i
- 500D
- REBELT3
- 1100D

You can control your camera from EU and shoot movies from your computer screen. You cannot shoot movies without a memory card in your camera.

- 1D X
- 1D Mk IV

## 1 Prepare for Live View shooting.

- Follow the procedure from step 1 to step 3 for “Remote Live View Shooting” (p.27).

## 2 Click [Live View/Movie func. set.].

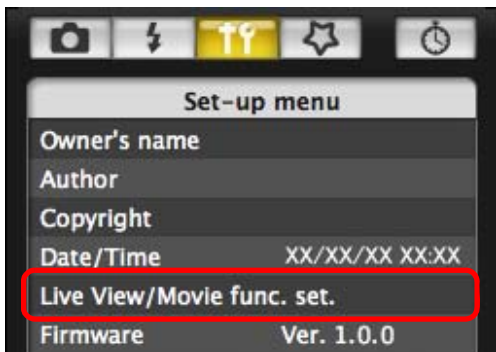

→ The [Live View/Movie func. set.] window appears.

## 3 Select [Movies] for [LV func. setting], and select the movie recording size from the list box.

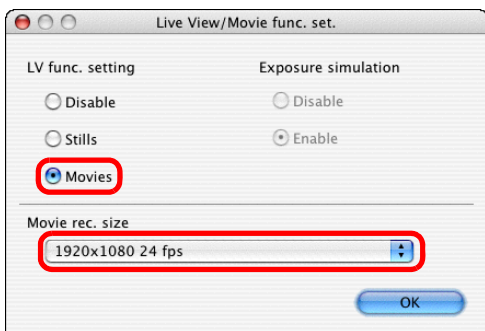

The following kinds of movie compression formats are selectable on

1D X .

- ALL-I (I-only): Compresses one frame at a time for recording. Although the file size will be larger than with IPB, the movie will be more suited for editing.
- IPB: Compresses multiple frames at a time efficiently for recording. Since the file size will be smaller than with ALL-I, you can shoot longer.

## 4 Click the [OK] button.

→ The [Live View/Movie func. set.] window closes.

## 5 Click [Live View shoot.].



→ The [Remote Live View window] appears.

- On 1D X , specify audio recording settings as needed. For specifying audio recording settings, see “Audio Recording Setting” (p.45).

## 6 Adjust the focus. (p.35, p.36).

Introduction

Contents at a Glance

Downloading Images

Camera Settings

Remote Shooting

Preferences

Reference

Index

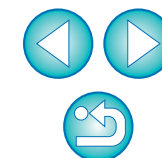

## 7 Click the [ ] button and begin shooting.

→ At the bottom left of the [Remote Live View window], a [  ] icon and the recording time are displayed.

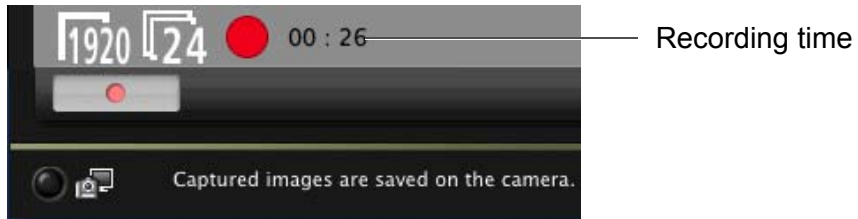

- Click the [  ] button again to end shooting.
- When the [Remote Live View window] closes, the following window appears if some image data remains to be downloaded to your computer.

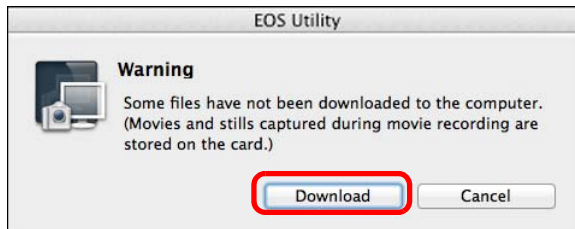

- After you click the [Download] button, the file names of the image data shot in movie mode (movie/still image) appear in a list.



After specifying [Destination Folder] and [File Name], click the [Download] button in the window, and image data will be downloaded from the camera's memory card to your computer. Image data having a check mark removed from its file name are not downloaded. Afterward, when downloading image data to your computer from the camera's memory card, use the method described on [p.6](#) to [p.10](#) of this Instruction Manual to download.

Introduction

Contents at a Glance

Downloading Images

Camera Settings

Remote Shooting

Preferences

Reference

Index

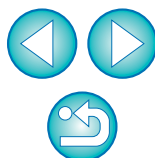

## 1 Prepare for Live View shooting.

- Follow the procedure from step 1 to step 3 for “Remote Live View Shooting” (p.27).

## 2 Click [Live View/Movie func. set.].

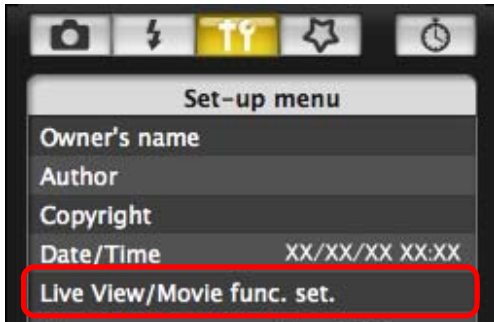

→ The [Live View/Movie func. set.] window appears.

## 3 Select [Stills+movie] and [Movie display], set the movie recording size.

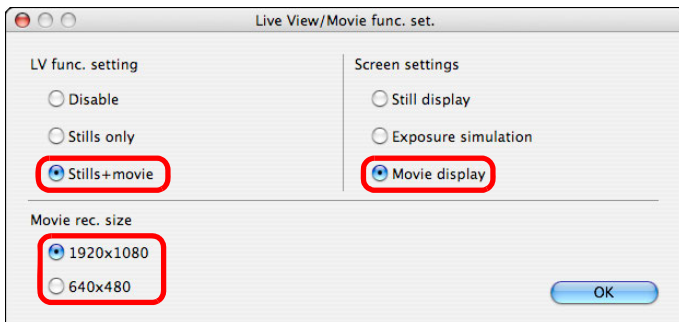

- ⚠ You cannot shoot movies when [Screen settings] is set to [Still display] or [Exposure simulation].
- If the camera firmware is Ver.2.0.0 or later, set the frame rate on the camera. Note that if the frame rate has been set to 24 fps on the camera, if you change the movie recording size with EU, the frame rate will be changed to another setting.

## 4 Click the [OK] button.

→ The [Live View/Movie func. set.] window closes.

## 5 Click [Live View shoot.].

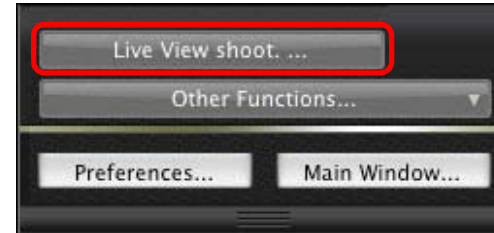

→ The [Remote Live View window] appears.

## 6 Adjust the focus. (p.35, p.36).

## 7 Click the [ ] button and begin shooting.

→ At the bottom left of the [Remote Live View window], a [ ] icon and the recording time are displayed.

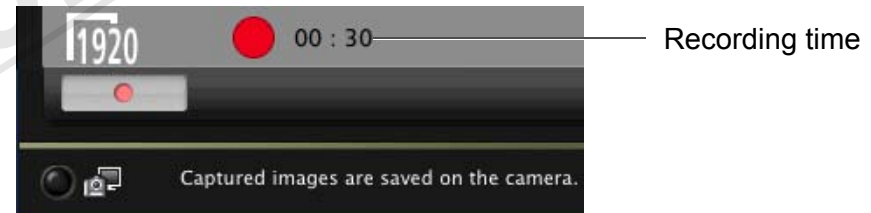

- Click the [ ] button again to end shooting.
- When the [Remote Live View window] closes, the following window appears if some image data remains to be downloaded to your computer.

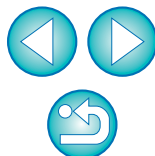
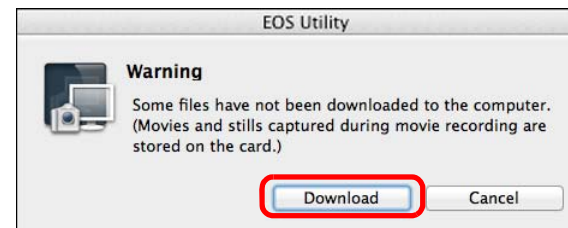



- After you click the [Download] button, the file names of the image data shot in movie mode (movie/still image) appear in a list.

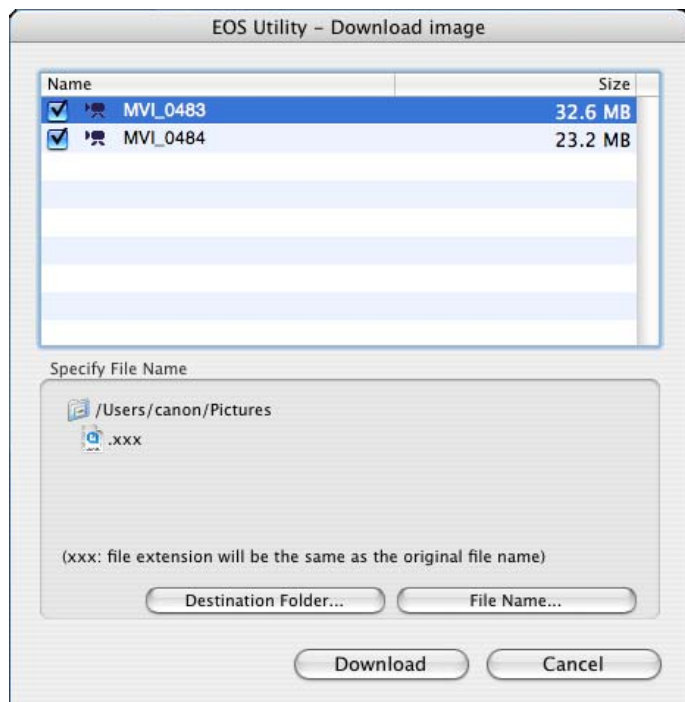

After specifying [Destination Folder] and [File Name], click the [Download] button in the window, and image data will be downloaded from the camera's memory card to your computer. Image data having a check mark removed from its file name are not downloaded. Afterward, when downloading image data to your computer from the camera's memory card, use the method described on p.6 to p.10 of this Instruction Manual to download.

5D Mk III 7D REBELT3 1100D



## 1 Prepare for Live View shooting.

- Follow the procedure of step 1 and step 2 for "Remote Live View Shooting" (p.27).
- On 5D Mk III 7D, set your camera's Live View shooting/Movie shooting switch to <  >.

## 2 Click the [ ] button.



- The [Remote Live View window] appears.
- On 5D Mk III, specify audio recording settings as needed. For specifying audio recording settings, see "Audio Recording Setting" (p.45).

-  You cannot operate the camera when the [  ] button is clicked. To operate the camera, click the [  ] button again or close the [Remote Live View window].
- You cannot shoot still photos in movie mode with REBELT3 1100D.

Introduction

Contents at a Glance

Downloading Images

Camera Settings

Remote Shooting

Preferences

Reference

Index

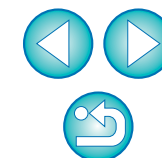

When setting the movie recording size, click [Live View/Movie func. set.], and display the [Live View/Movie func. set.] window before setting.

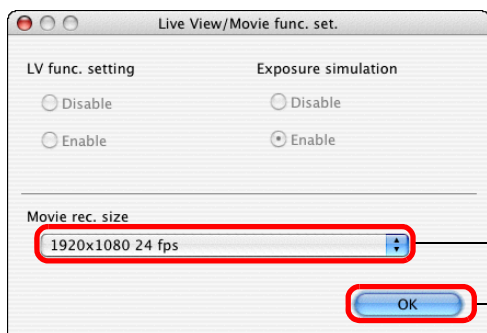

Select

Click

- Selectable movie recording sizes depend on the camera.

The following movie compression formats can be selected on

**5D Mk III**.

- ALL-I (I-only): Compresses one frame at a time for recording. Although the file size will be larger than with IPB, the movie will be more suited for editing.
- IPB: Compresses multiple frames at a time efficiently for recording. Since the file size will be smaller than with ALL-I, you can shoot longer.

**3 Adjust the focus. (p.35, p.36).**

**4 Click the [  ] button and begin shooting.**

→ At the bottom left of the [Remote Live View window], a [  ] icon and the recording time are displayed.

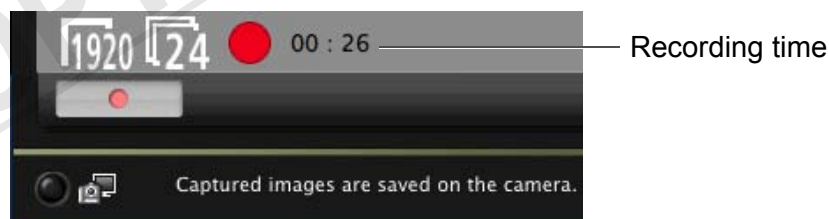

• Click the [  ] button again to end shooting.

→ When the [Remote Live View window] closes, the following window appears if some image data remains to be downloaded to your computer.



• After you click the [Download] button, the file names of the image data shot in movie mode (movie/still image) appear in a list.

Introduction

Contents at a Glance

Downloading Images

Camera Settings

Remote Shooting

Preferences

Reference

Index

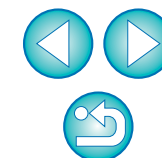

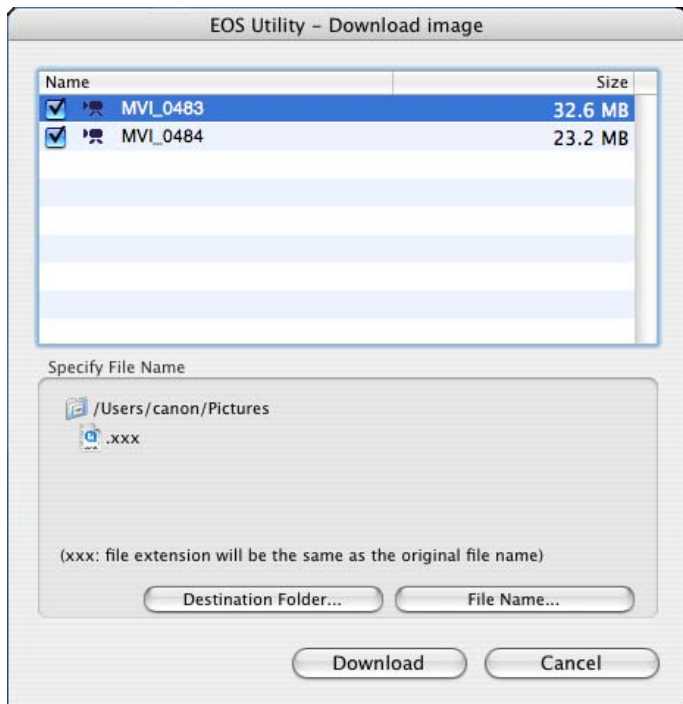

After specifying [Destination Folder] and [File Name], click the [Download] button in the window, and image data will be downloaded from the camera's memory card to your computer. Image data having a check mark removed from its file name are not downloaded. Afterward, when downloading image data to your computer from the camera's memory card, use the method described on p.6 to p.10 of this Instruction Manual to download.

60D



## 1 Prepare for Live View shooting.

- Follow the procedure of step 1 and step 2 for "Remote Live View Shooting" (p.27).

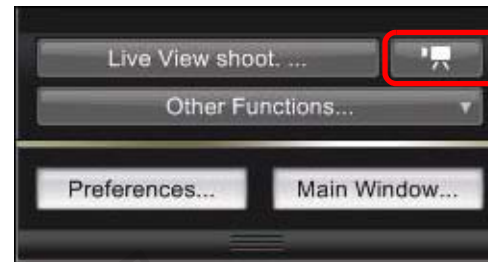
## 2 Click the [ ] button.



→ The [Remote Live View window] appears.

**!** You cannot operate the camera when the [  ] button is clicked. To operate the camera, click the [  ] button again or close the [Remote Live View window].

Introduction

Contents at a Glance

Downloading Images

Camera Settings

Remote Shooting

Preferences

Reference

Index

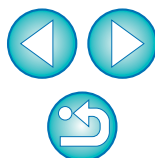

When setting the movie recording size, movie shooting mode, etc., click [Live View/Movie func. set.], and display the [Live View/Movie func. set.] window before setting.

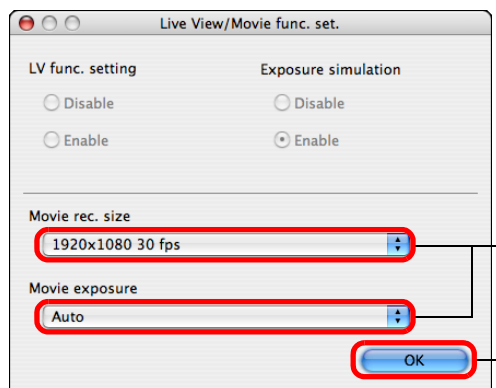

Select

Click

Note the following when you set the movie recording size to [Movie Crop 640 x 480].

- The Movie crop image cannot be magnified for focusing.
- Two AF modes can be selected, [Live mode] (p.38) and [Face Detection Live mode] (p.39).
- AF mode automatically switches to [Live mode] (p.38) when in [Quick mode] (p.36).
- Still photos cannot be taken.
- The movie recording size icon appears as [640].

### 3 Adjust the focus (p.35, p.36).

### 4 Click the [ ] button and begin shooting.

→ At the bottom left of the [Remote Live View window], a [  ] icon and the recording time are displayed.

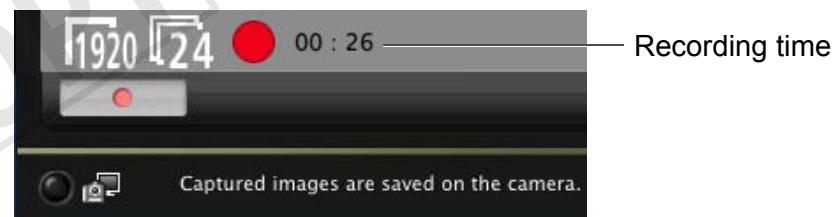

• Click the [  ] button again to end shooting.

→ When the [Remote Live View window] closes, the following window appears if some image data remains to be downloaded to your computer.

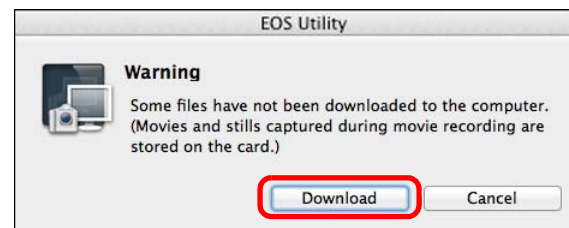

• After you click the [Download] button, the file names of the image data shot in movie mode (movie/still photo) appear in a list.

Introduction

Contents at a Glance

Downloading Images

Camera Settings

Remote Shooting

Preferences

Reference

Index

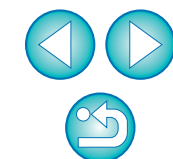

REBEL4i 650D REBEL3i 600D REBEL2i 550D

## 1 Prepare for Live View shooting.

- Follow the procedure of step 1 and step 2 for “Remote Live View Shooting” (p.27).



## 2 Click the [ ] button.



→ The [Remote Live View window] appears.

- On REBEL4i 650D, specify audio recording settings as needed.

For specifying audio recording settings, see “Audio Recording Setting” (p.45).

 You cannot operate the camera when the [  ] button is clicked. To operate the camera, click the [  ] button again or close the [Remote Live View window].

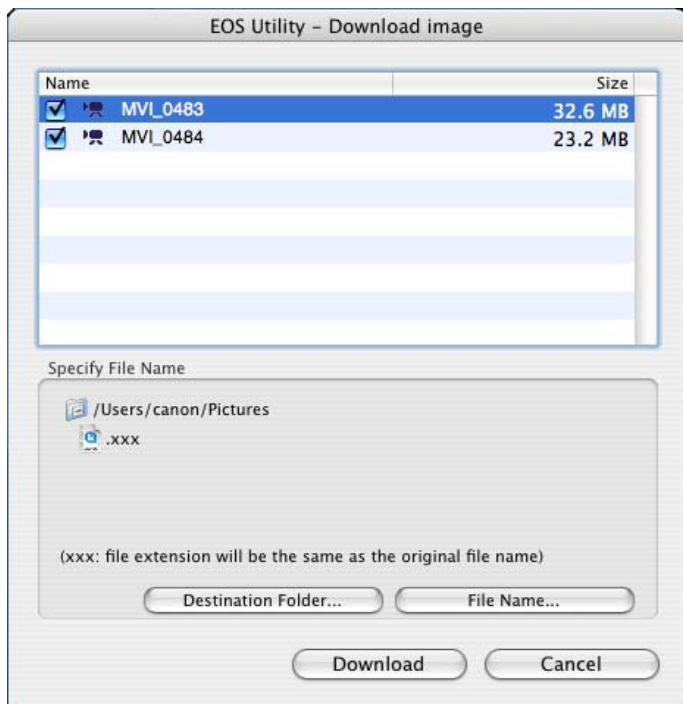

After specifying [Destination Folder] and [File Name], click the [Download] button in the window, and image data will be downloaded from the camera’s memory card to your computer. Image data having a check mark removed from its file name are not downloaded. Afterward, when downloading image data to your computer from the camera’s memory card, use the method described on p.6 to p.10 of this Instruction Manual to download.

Introduction

Contents at a Glance

Downloading Images

Camera Settings

Remote Shooting

Preferences

Reference

Index

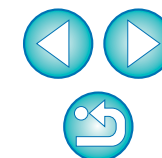

When setting the movie recording size, click [Live View/Movie func. set.], and display the [Live View/Movie func. set.] window before setting.

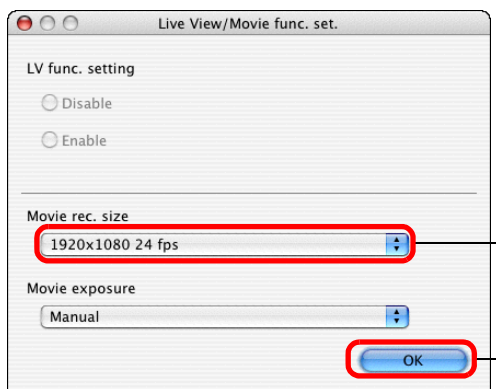

Select

Click

- Note the following when you set the movie recording size to [Movie Crop 640 x 480] on **REBELT2i** **550D** .
  - The Movie crop image cannot be magnified for focusing.
  - Two AF modes can be selected, [Live mode] (p.38) and [Face Detection Live mode] (p.39).
  - AF mode automatically switches to [Live mode] (p.38) when in [Quick mode] (p.36).
  - Still photos cannot be taken.
  - The movie recording size icon appears as [640].
- The following operations are not available when Movie Digital Zoom is set on **REBELT3i** **600D** .
  - Remote Live View display
  - AF focusing
  - Shooting still photos
- In EU, Video Snapshot shooting is not available on **REBELT4i** **650D** **REBELT3i** **600D** .

**3 Adjust the focus.** (p.35, p.36).

**4 Click the [  ] button and begin shooting.**

→ At the bottom left of the [Remote Live View window], a [  ] icon and the recording time are displayed.

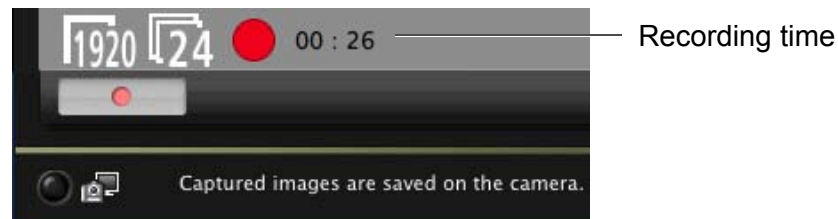

● Click the [  ] button again to end shooting.

→ When the [Remote Live View window] closes, the following window appears if some image data remains to be downloaded to your computer.

Introduction

Contents at a Glance

Downloading Images

Camera Settings

Remote Shooting

Preferences

Reference

Index

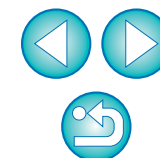

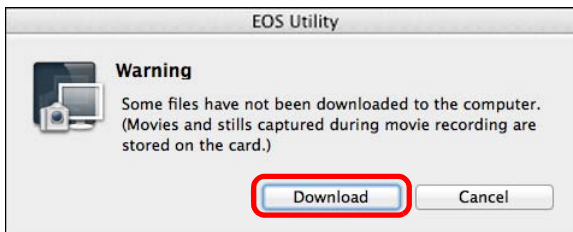

- After you click the [Download] button, the file names of the image data shot in movie mode (movie/still image) appear in a list.

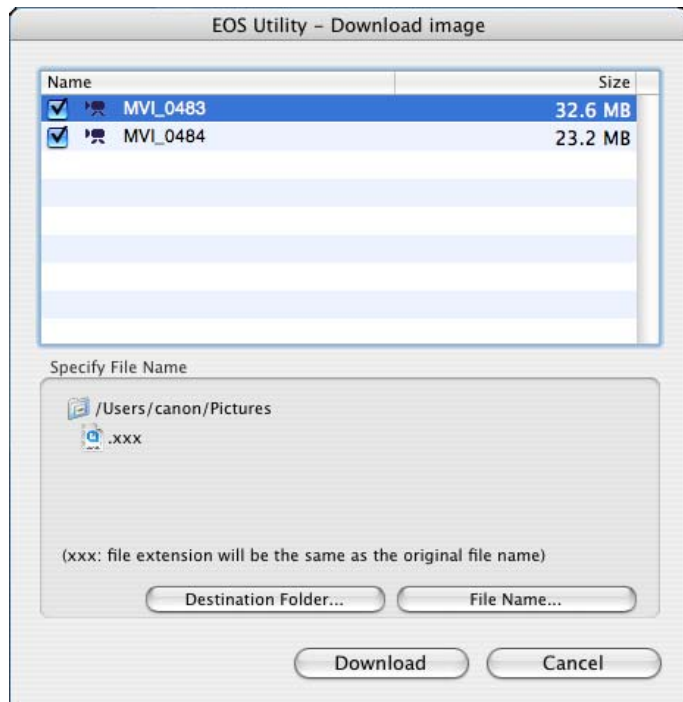

After specifying [Destination Folder] and [File Name], click the [Download] button in the window, and image data will be downloaded from the camera's memory card to your computer. Image data having a check mark removed from their file name are not downloaded. Afterward, when downloading image data to your computer from the camera's memory card, use the method described on p.6 to p.10 of this Instruction Manual to download.

REBELT1i 500D

## 1 Prepare for Live View shooting.

- Follow the procedure of step 1 and step 2 for "Remote Live View Shooting" (p.27).

## 2 Set the camera's Mode Dial to < [Live View] >.

- When setting the movie recording size, click [Live View/Movie func. set.], display the [Live View/Movie func. Set.] window before setting.

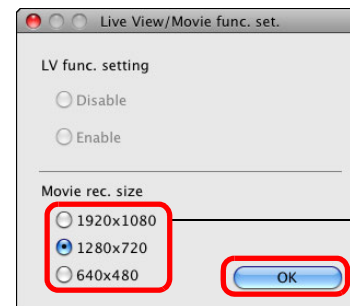
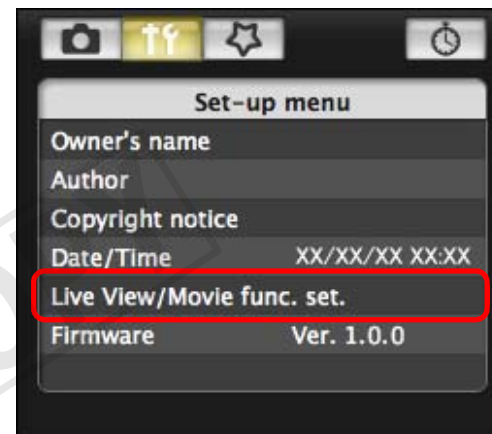

Select

Click

Introduction

Contents at a Glance

Downloading Images

Camera Settings

Remote Shooting

Preferences

Reference

Index

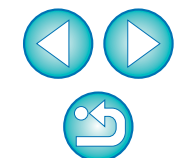

### 3 Click [Live View shoot].





→ The [Remote Live View window] appears.

### 4 Adjust the focus. (p.35, p.36).

### 5 Click the [ ] button and begin shooting.

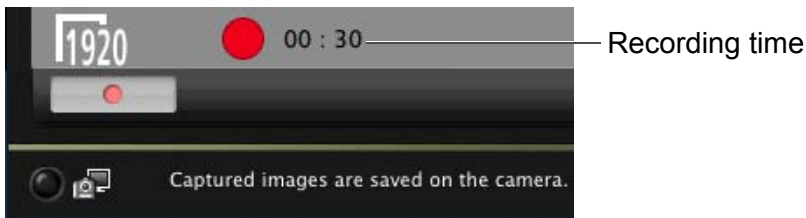
→ At the bottom left of the [Remote Live View window], a [  ] icon and the recording time are displayed.



● Click the [  ] button again to end shooting.

→ When the [Remote Live View window] closes, the following window appears if some image data remains to be downloaded to your computer.

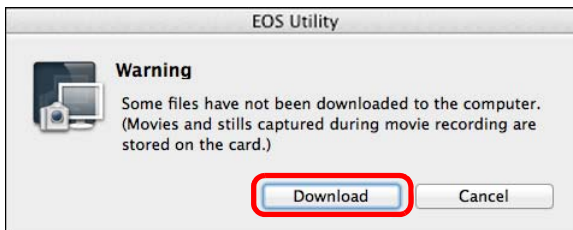

● After you click the [Download] button, the file names of the image data shot in movie mode (movie/still image) appear in a list.

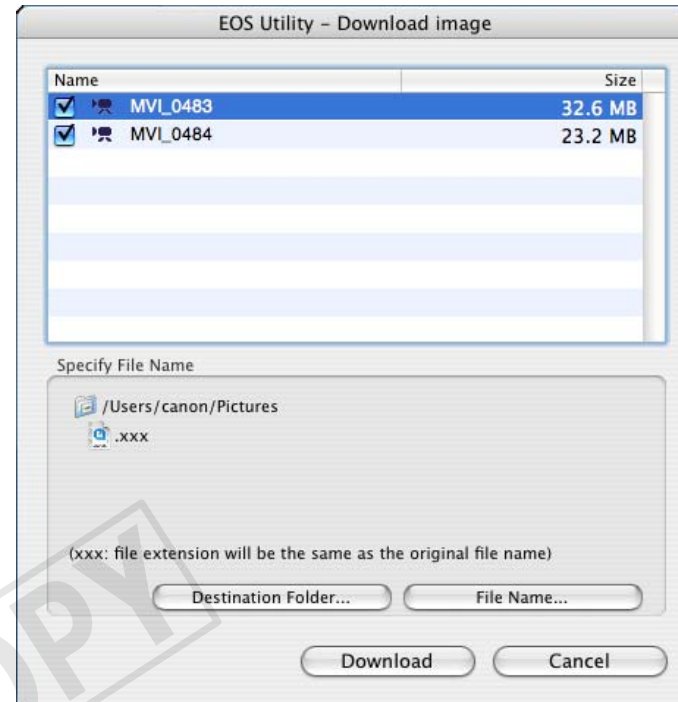

After specifying [Destination Folder] and [File Name], click the [Download] button in the window, and image data will be downloaded from the camera's memory card to your computer. Image data having a check mark removed from its file name are not downloaded. Afterward, when downloading image data to your computer from the camera's memory card, use the method described on p.6 to p.10 of this Instruction Manual to download.

Introduction

Contents at a Glance

Downloading Images

Camera Settings

Remote Shooting

Preferences

Reference

Index

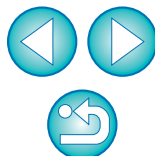



# Timer-controlled Shooting

Two types of timer shooting are available where the camera automatically takes shots at a specified time or a specified number.

## Timer Shooting

You can automatically take a shot when the specified time elapses.

- 1 **Display the capture window (p.27).**
- 2 **Click the [  ] button.**
  - The [Timer shooting settings] dialog box appears.
- 3 **Enter a delay time and click the [Start] button.**
  - Enter a value between 0 seconds and 99 minutes and 59 seconds in one-second increments.
  - The shot is taken when the specified time elapses.

## Interval Timer Shooting

You can automatically take shots by setting the interval between shots and the number of shots to be taken.

- 1 **Display the capture window (p.27).**
- 2 **Click the [  ] button.**
  - The [Timer shooting settings] dialog box appears.
- 3 **Checkmark [Interval timer shooting].**
- 4 **Enter the shooting interval and the number of shots.**
  - Enter a value between 5 seconds and 99 minutes and 59 seconds in one-second increments.
  - The minimum number of interval-timed shots is two. The number of shots you can take at timed intervals depends on the available space on your computer's hard disk.
- 5 **Click the [Start] button.**
  - The shots are taken at the specified intervals and for the specified number of shots.

 On certain types of computer, if you set a short interval between shots and there is insufficient time to transfer and save the images, it may not be possible to take shots at the specified interval. In this case, set a longer interval between shots and take the shots again.

 The shooting mode cannot be changed when the [Timer shooting settings] dialog box is displayed. Display the [Timer shooting settings] dialog box after setting the shooting mode.

Introduction

Contents at a Glance

Downloading Images

Camera Settings

Remote Shooting

Preferences

Reference

Index

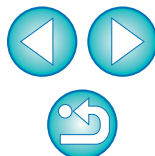

## Bulb Exposures

- 1 Display the capture window (p.27).
- 2 Double-click the shooting mode icon and select [BULB].



- Specify the following settings for cameras other than 1D X, 1D Mk IV, 1Ds Mk III, 1D Mk III.
  - For cameras with < B > (bulb) on the Mode dial, set to < B >.
  - For cameras without < B > (bulb) on the Mode dial, set the Mode dial to < M > (manual), and select [BULB] in the capture window or set the camera's shutter speed to [BULB].

- 3 Set the desired aperture.

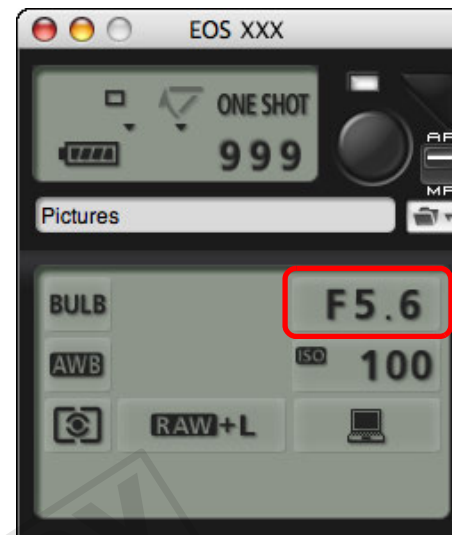

- 4 Click the [ ] button.
  - The [Timer shooting settings] dialog box appears.
- 5 Enter the exposure time and click the [Start] button.
  - Enter a value between 5 seconds and 99 minutes and 59 seconds in one-second increments.

 You can start/end bulb exposure without setting an exposure time by clicking the [●] button.

Introduction

Contents at a Glance

Downloading Images

Camera Settings

Remote Shooting

Preferences

Reference

Index

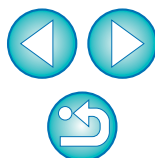

# Flash Shooting



1D X 1D Mk IV 5D Mk III 5D Mk II 7D 60D REBELT4i

650D REBELT3i 600D REBELT2i 550D REBELT3 1100D

From EU you can set the camera's flash functions, as well as EX-series Speedlite (sold separately) compatible with flash function setting, in order to perform flash shooting.

For more details on setting items, also refer to the Instruction Manual provided with your EX-series Speedlite and with your camera.

## 1 Prepare your camera and flash.

- When using an external flash, mount it on your camera.

## 2 Connect your camera and computer, and then start up EU (p.5).

## 3 Click [Camera settings/Remote shooting].



→ The capture window appears.

## 4 Click the [ ] button.

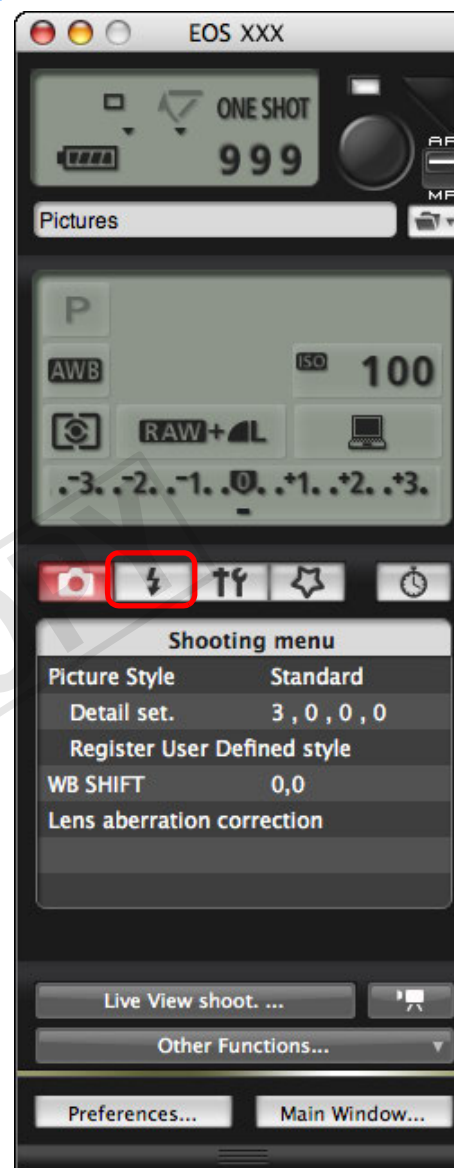

→ The [Flash control menu] appears.

Introduction

Contents at a Glance

Downloading Images

Camera Settings

Remote Shooting

Preferences

Reference

Index

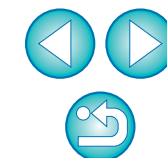

# 5 Click [Flash function settings].

## Flash control menu

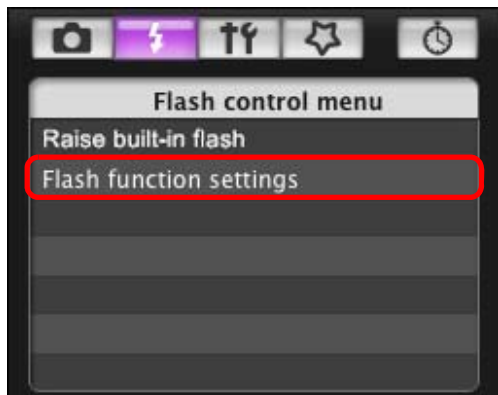

- When **REBELT4i**, **650D**, **REBELT3i**, **600D** is connected, [Built-in flash] is also displayed.

You can change the way you set the built-in flash functions by selecting setting items displayed in [Built-in flash].

Refer to your camera's Instruction Manual for details on setting items ([NormalFiring], [EasyWireless], [CustWireless]).

- The [Flash function settings] window appears.

COPY

Select [Raise built-in flash] to use the built-in flash on **7D**, **60D**, **REBELT4i**, **650D**, **REBELT3i**, **600D**, **REBELT2i**, **550D**, **REBELT3**, **1100D**.

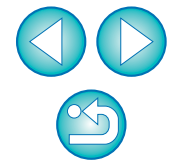

## 6 Specify settings.

### Flash function settings window

The window displayed differs depending on the connected camera and flash.

Check that this box is checkmarked

Click setting items, and select settings from the menu that appears\*

Enable the wireless function, click the setting items, and then select settings from the menu that appears\*

[Wireless func.] button

1D X 1D Mk IV 5D Mk III 5D Mk II REBELT2i 550D REBELT3 1100D

To enable the wireless function, click the button and select [Enable] from the menu that appears. To cancel, select [Disable] from the menu.

7D 60D REBELT4i 650D REBELT3i 600D

To enable the wireless function, click the button and select the flash combination from the menu that appears. To cancel, select [Disable] from the menu.

To enable the wireless function for the built-in flash on the REBELT4i 650D REBELT3i 600D, select [Built-in flash] in [Flash control menu], then select [EasyWireless] or [CustWireless]. To cancel, select [NormalFiring].

\* You can also use the scroll-wheel on your mouse to select settings for items in the settings window that appears.

Introduction

Contents at a Glance

Downloading Images

Camera Settings

Remote Shooting

Preferences

Reference

Index

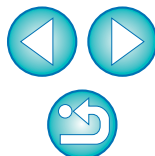

**!** If the [Flash control] menu is displayed on the camera's LCD monitor, EU [Flash function settings] window automatically closes.

- You can use modeling flash by clicking the [Modeling flash] button. You should only use modeling flash for a maximum of 10 times continuously. (For more information, refer to the Instruction Manual provided with the flash.)
- Information displayed in the [Flash function settings] window is updated by clicking the [ ] button, so it is synchronized with the current flash settings. (Since setting changes made with the flash unit are not reflected in the [Flash function settings] window, you can click the [ ] button and update the [Flash function settings] window to match the current flash settings.)
- You can name and save the flash setting as a file separate from the image by clicking the [Save] button. You can also click the [Load] button and load this file into EU for use in other shooting.
- You can use flash shooting and Remote Live View shooting (p.27) together. However, you cannot use modeling flash during Remote Live View shooting.
- Settings that can be performed in the [Flash function settings] window differ depending on the flash and camera.

## 7 Click the [●] button to shoot.

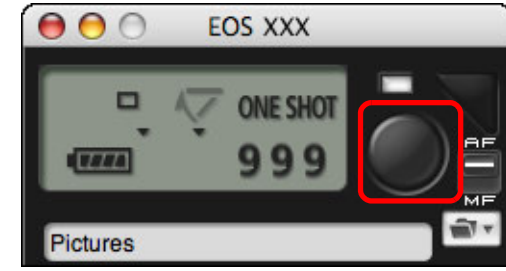

- The shot image is transferred to your computer and displayed in the [Quick Preview] window. Then, DPP starts up automatically.
- When the capture window AF/MF selector is set to [AF], AF/AE is executed when the cursor is moved to the [●] button. (p.91)
- You can quickly review the shot image in the [Quick Preview] window displayed before DPP starts up. You can also resize the [Quick Preview] window.
- You can show/hide the [Quick Preview] window by clicking the [Other Functions] button in the capture window and selecting [Quick Preview] from the menu that appears.

- For a list of [Flash function settings] window functions, see p.93.
- You can also shoot using the <space> bar on the keyboard.

Introduction

Contents at a Glance

Downloading Images

Camera Settings

Remote Shooting

Preferences

Reference

Index

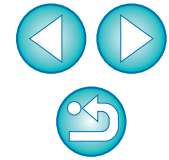

# Registering Background Music to a Camera Memory Card

REBELT4i 650D REBELT3i 600D

You can register WAV-format music files, saved to your computer, to the camera's memory card as background music. Registered background music can be played together with a Video Snapshot Album or slideshow played on the camera.

## 1 Connect your camera and computer, and then start EU (p.5).

- If your camera and computer are not connected, [Register Background Music] is not displayed.

## 2 Click [Register Background Music].



- The [Register Background Music] window appears.
- When the [EOS Sample Music] folder is installed to your computer, five tracks appear in [List of background music to register] the first time as EOS Sample Music.
- When the camera is in movie shooting mode, registering background music is not possible.

## Register Background Music window

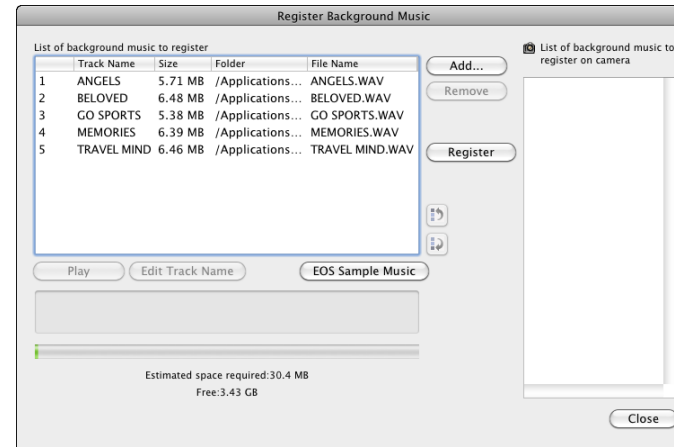

## 3 Edit [List of background music to register]. Adding New Music Files

- Click the [Add] button, select a music file in the [Open] dialog box that appears, and then click the [Open] button.

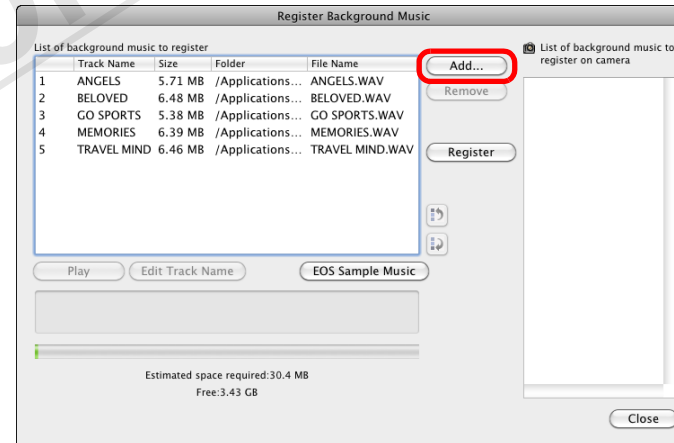

- A music file is added to [List of background music to register].
- You can also directly drag and drop a music file saved anywhere in your computer to add it to [List of background music to register].
- Music can be added only one track at a time.
- A total of 20 tracks can be added, each up to 29 minutes 59 seconds long.

Introduction

Contents at a Glance

Downloading Images

Camera Settings

Remote Shooting

Preferences

Reference

Index

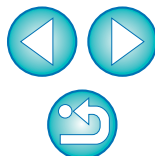

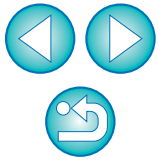

### Changing the Playback Order of Music Files

- Select a music file in [List of background music to register], and then click the [↔] or [↕] button.

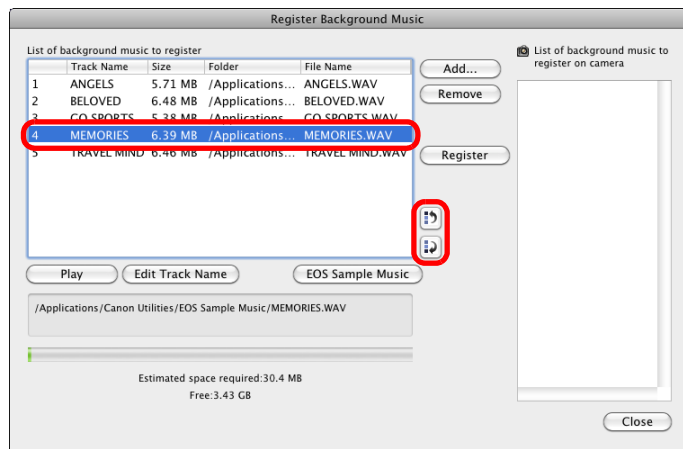

→ The order of the music files changes.

- You can also directly drag and drop music files within the [List of background music to register] to change the order.

### Deleting Music Files

- Select a music file in [List of background music to register], and then click the [Remove] button.

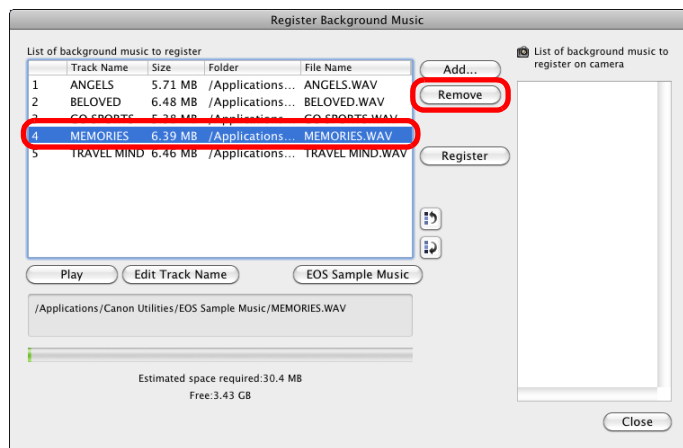

→ The music file is deleted from [List of background music to register].

### Editing Track Names of Music Files

- Select a music file in [List of background music to register], click the [Edit track Name] button and enter a track name up to 25 characters (single-byte). Then, click the [OK] button.

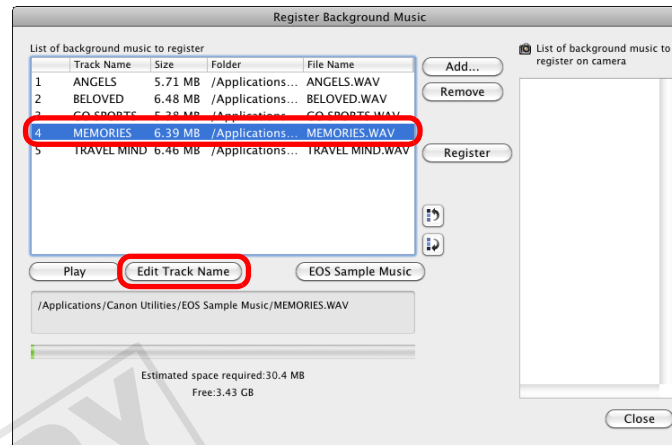

→ The track name for the music file changes.

- You can also display the [Edit Track Name] dialog box by double-clicking a music file in the [List of background music to register].

### Playing Music Files

- Select a music file in [List of background music to register], and then click the [Play] button.

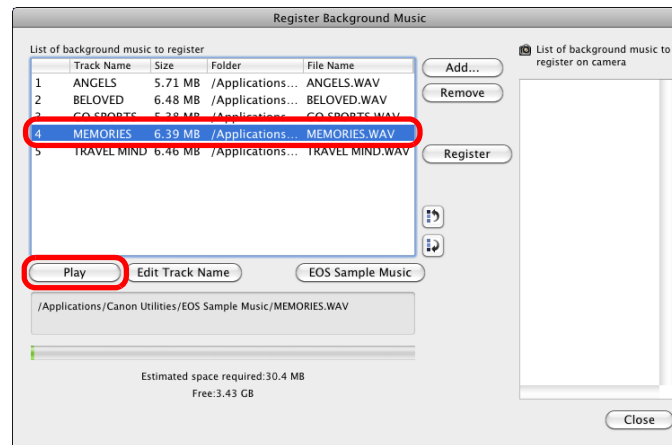

→ The music file plays.



## Adding EOS Sample Music

- Click the [EOS Sample Music] button.

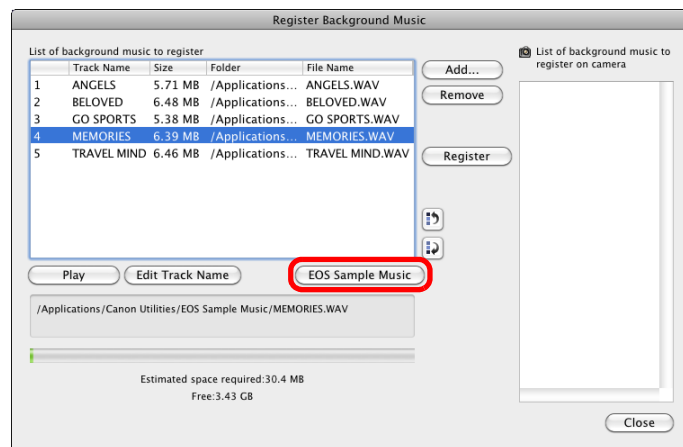

- The EOS Sample Music on your computer is added to [List of background music to register].
- This operation cannot be performed if EOS Sample Music is not installed on your computer.

## 4 Click the [Register] button.

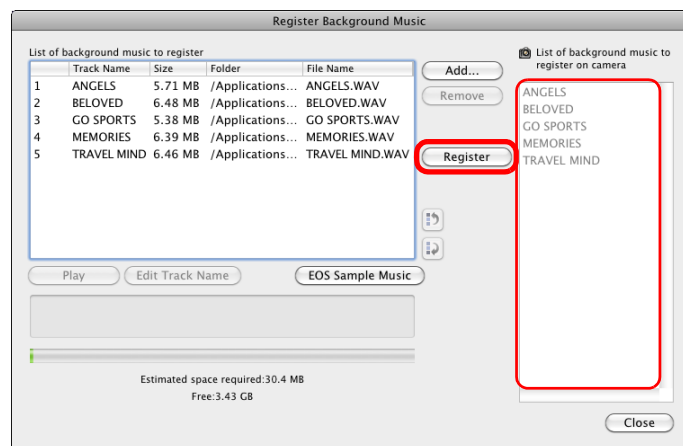

- The music files in [List of background music to register] are registered (copied) to the camera's memory card.

- Music files already registered on the camera's memory card are overwritten as music files are registered.
- Registering music files to your camera one track at a time is not possible.

## 5 Click the [Close] button.

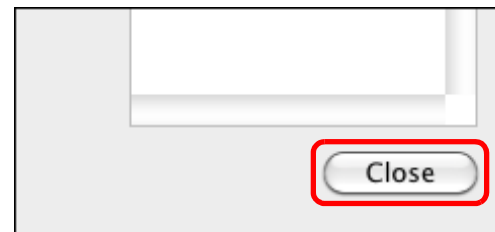

- The [Register Background Music] window closes.

COPY

**!** Music copied through this function may not be used without permission from the copyright holder, except for cases permitted under applicable laws, such as for personal use.

**📄** Music files meeting the following requirements may be registered to the camera's memory card.

File format	Music file export: WAVE (.wav, .wave) files in linear PCM
File time limit	Up to 29 min. 59 sec. per one file
File number limit	Up to 20 files
Channels	2 channels

Introduction

Contents at a Glance

Downloading Images

Camera Settings

Remote Shooting

Preferences

Reference

Index

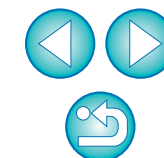

# 4 Preferences



You can change each of the EU functions on each window of the preferences window to make them easier to use.

---

Preferences .....	74
Basic Settings.....	74
Destination Folder .....	74
File Name .....	75
Download Images.....	75
Remote Shooting.....	76
Linked Software.....	77
Time Settings.....	77

Introduction

Contents at a Glance

Downloading Images

Camera Settings

Remote Shooting

**4**  
Preferences

Reference

Index

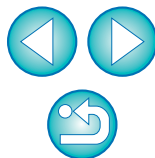

# Preferences

**1** On the main window, click the [Preferences] button.

→ The [Preferences] dialog box appears.

**2** Specify the required settings and click the [OK] button.

→ The settings are applied to EU.

## Basic Settings

You can specify the operation when EU starts up and whether the auto power off function is enabled or disabled.

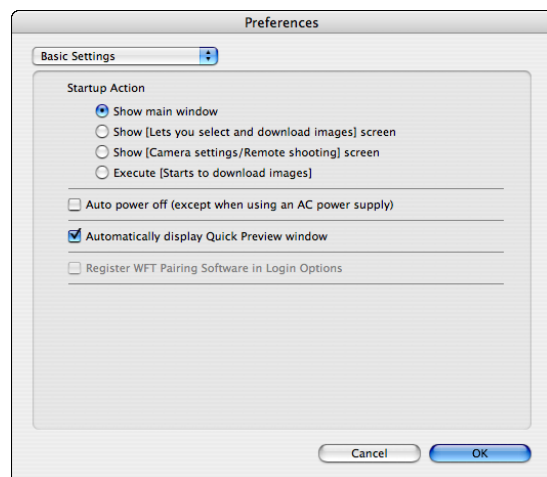

- When [Show [Lets you select and download images] screen] is selected in [Startup Action], the viewer window (p.88) appears.
- When [Show [Camera settings/Remote shooting] screen] is selected in [Startup Action], the capture window (p.91) appears.
- When [Execute [Starts to download images]] is selected in [Startup Action], the [Save File] dialog box (p.6) appears and downloading to your computer begins. When all the images have been downloaded, DPP starts up automatically and the downloaded images are displayed in DPP's main window.
- If you checkmark [Auto power off], the camera's auto power off function is enabled. If you remove the check mark, the auto power off function remains disabled, even if you set the auto power off function on the camera (only when the camera is connected to a computer.).
- If you remove the check mark from [Automatically display Quick Preview window], the [Quick Preview] window will no longer appear during Remote Live View shooting or when loading images.
- If you checkmark [Register WFT Pairing Software in Login Options], the WFT pairing software is added to the login items displayed when the [Accessories] tab sheet is selected in the main window.

## Destination Folder

You can specify the save destination folder of images downloaded from your camera or of images shot remotely.

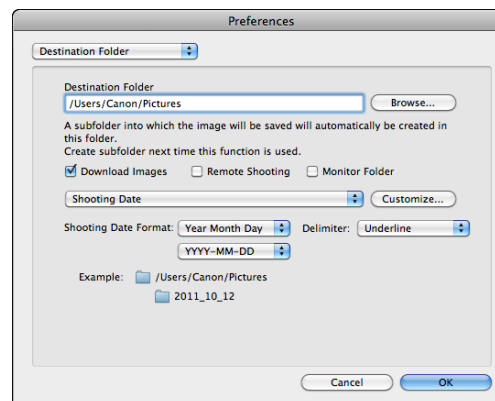

Introduction

Contents at a Glance

Downloading Images

Camera Settings

Remote Shooting

Preferences

Reference

Index

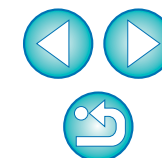

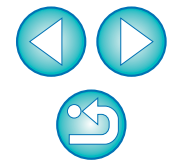

- You can also specify a save destination folder by entering text directly in the textbox for the save destination folder.
- To specify a save destination folder, click the [Browse] button. After you click the [Browse] button and specify a save destination folder, a subfolder is created automatically below the save destination folder you specified.
- After you checkmark any of [Download Images], [Remote Shooting], or [Monitor Folder], a subfolder is generated when the checkmarked function is used.
- You can select the naming rule for a generated subfolder from the list box. You can also customize the naming rule for subfolders by clicking the [Customize] button.
- If you are using the shooting date for a generated subfolder, you can specify the format (order and style for year-month-date) and dividing characters.

- When specifying an image's file name, select a naming rule for the file from the list box. (If [Do not modify] is selected, images are saved with the file name set in the camera.) You can also customize the naming rule for files by clicking the [Customize] button.
- You can set prefix characters, number of digits for serial numbers, and the start number individually for file names.
- If you are using the shooting date in file names, you can specify the format (order and style for year-month-date) and dividing characters.

### Download Images

From the list box, you can select the images to be downloaded when [Starts to download images] in the main window is clicked.

### File Name

You can specify the file name of images downloaded from your camera or of images shot remotely.

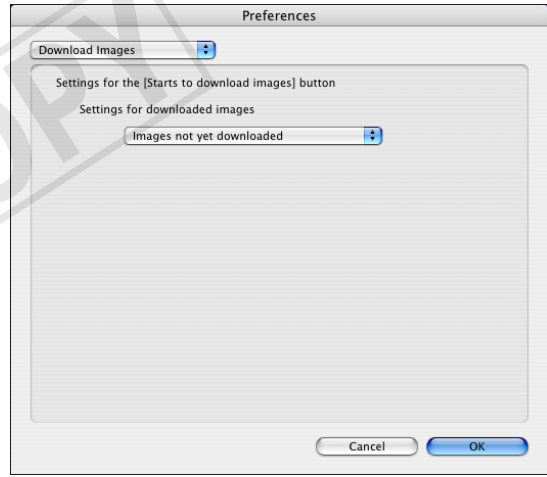
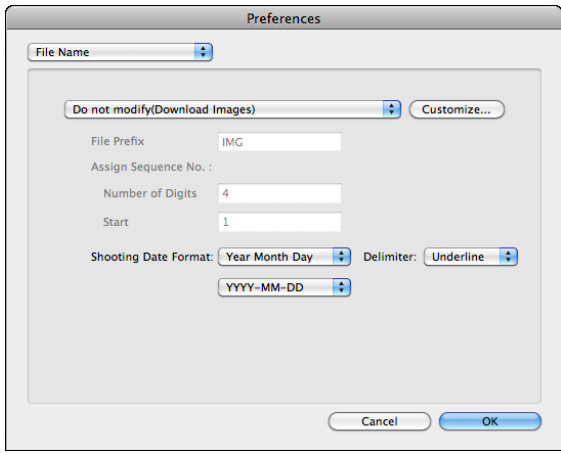

[Images whose transfer settings were specified with the camera] in the [Settings for downloaded images] menu is only enabled for cameras capable of direct transfer of shot images. Refer to your camera's Instruction Manual for details.

## Remote Shooting

You can set operations performed during remote shooting.

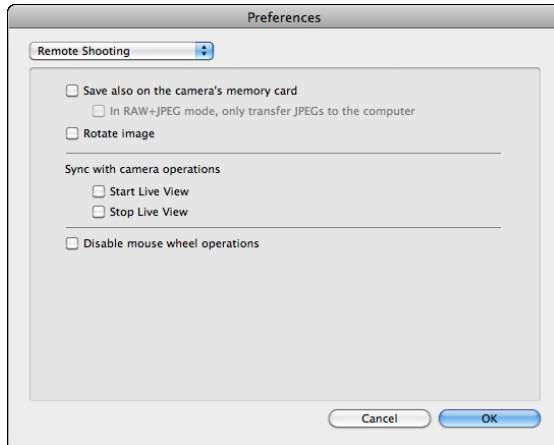

- If you checkmark [Save also on the camera's memory card], images shot during remote shooting will also be saved to the camera's memory card.
  - If you checkmark [In RAW+JPEG mode, only transfer JPEGs to the computer], only the JPEG image of images shot in RAW+JPEG recording quality with remote shooting will be transferred to your computer.
  - If you checkmark [Rotate image], you can set a function that rotates shot images regardless of the camera's position during shooting. Set the rotation angle in the capture window (p.91).
  - If you checkmark [Start Live View], the [Remote Live View window] automatically appears when the camera's Live View starts up.
  - If you checkmark [Stop Live View], the [Remote Live View window] automatically closes when the camera's Live View ends.
- On 1D X 1D Mk IV 5D Mk III 7D 60D REBEL4i 650D REBEL3i 600D REBEL2i 550D REBEL3 1100D, if the camera's Live View display is active when Remote Live View ends, the camera's Live View display also ends.
- If you checkmark [Disable mouse wheel operations], you can no longer use the scroll-wheel on your mouse over the capture window display/control buttons or the [Flash function settings] window.

Introduction

Contents at a Glance

Downloading Images

Camera Settings

Remote Shooting

Preferences

Reference

Index

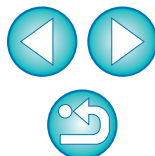

## Linked Software

From the list box, you can select the linked software that starts up when images are downloaded from the camera or when images are shot remotely. Also, you can register third-party software as linked software by clicking the [Apply] button.

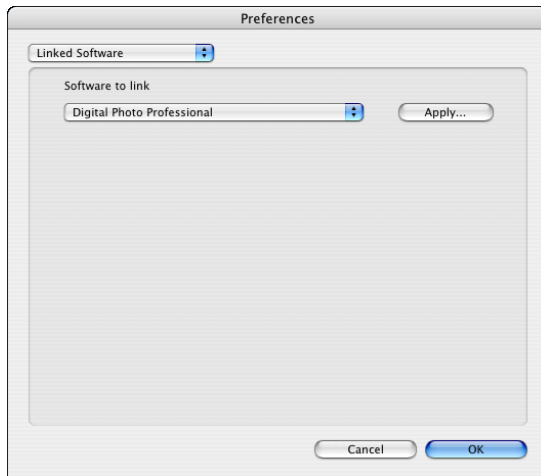

In the window displayed when you click the [Apply] button, you can specify the type of images to be posted when linked third-party software is started up.

## Time Settings

You can specify settings for clock time when connected to a camera.

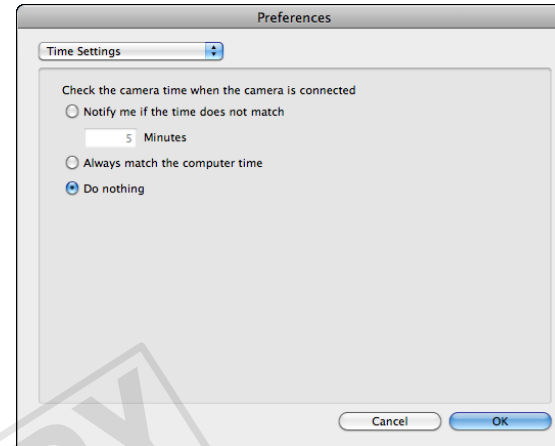

- When you select [Notify me if the time does not match], you can set the number of minutes, from 1 to 60 minutes, for which the camera clock and computer clock are out of sync before you are notified.  
When you start up EU, the camera clock and computer clock are compared. If the time difference exceeds the set number of minutes, a notification dialog box is displayed.
- When you select [Always match the computer time], the camera is set to the computer's time when you start up EU.

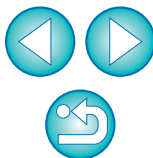



This reference section has been provided to enhance your experience using EU. It contains various troubleshooting solutions, how to delete EU from your computer and explanations of the various windows.

An index is provided at the end of the chapter for you to easily find information you are looking for.

---

Troubleshooting .....	79
Monitor Folder Function (Function for Use with the WFT-E2, WFT-E2 II, WFT-E3, WFT-E4, WFT-E4 II, WFT-E5, WFT-E6, or WFT-E7) .....	81
Function for Use with the Accessories .....	82
Folder Structure and File Names in the Memory Card .....	83
Uninstalling the Software .....	83
Fixing the Plug to the Camera .....	84
List of Main Window Functions .....	87
List of Viewer Window Functions .....	88
List of Register Data Window Functions for Lens Aberration and Peripheral Illumination Correction .....	89
List of My Menu Settings Window Functions .....	90
List of Capture Window Functions .....	91
Exposure Level/AEB Level .....	92
List of Flash Function Settings Window Functions .....	93
List of Remote Live View Window (Live View Tab) Functions .....	95
List of Remote Live View Window (Compose Tab) Functions .....	96
List of Zoom View Window Functions .....	97
List of Test Shooting Window Functions .....	98
Index .....	99
About This Instruction Manual .....	100
Trademark Acknowledgments .....	100

Introduction

Contents at a Glance

Downloading Images

Camera Settings

Remote Shooting

Preferences

Reference

Index

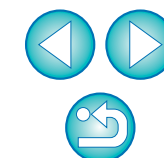

# Troubleshooting

If EU is not operating correctly, see the items below.

## Installation could not be completed correctly

- You cannot install software unless you are logged into an account with Administrator privileges. Log in again into an account with Administrator privileges.  
For how to log in and how to specify Administrator settings, refer to the User's Manual for the Macintosh computer or for Mac OS X.

## EU does not start up

- If you installed other software and EU no longer automatically starts up even if you connect your camera and computer, use the Image Capture (standard Macintosh software) settings to set the software that starts up at camera connection to [Camera Window] or [EOS Utility]. This must be set for each camera you will connect. You can disable EU from starting up automatically by selecting an option other than [Camera Window] or [EOS Utility].

## The card reader does not detect the SD card.

- Depending on the card reader and computer OS used, SDXC cards might not be correctly detected. In such a case, connect your camera and computer with the provided interface cable, and transfer the images to your computer.

## EU and the camera are not communicating

- EU does not operate correctly on a computer if its system requirements are not met. Use EU on a computer with compatible system requirements (p.2).
- Push the plug of the interface cable all the way into the socket. Loose connections can cause faults and malfunctions (p.5).
- Check that the camera's power switch is < ON > (p.6).
- EU and the camera may not communicate normally with a cable other than the EOS DIGITAL camera-dedicated Canon interface cable (p.5).
- Connect your camera and computer directly with the interface cable provided with your camera. Do not connect the camera via a hub; doing so may prevent EU and your camera from communicating normally.
- If you connect multiple USB devices (not including the mouse or keyboard) to your computer, the camera may not communicate normally. If the camera cannot communicate normally, disconnect USB devices other than the mouse or keyboard from your computer.
- Do not connect more than one camera to the same computer. Two or more cameras may not operate normally.
- Do not connect your camera with the computer while performing "Linked shooting" with a WFT series Wireless File Transmitter (sold separately). Your camera may not operate normally.
- If there is insufficient charge left in the camera battery, the camera cannot communicate with EU. Either replace with a fully charged battery or use the AC adaptor kit provided with your camera. Your computer does not supply power to the camera through the interface cable.

Introduction

Contents at a Glance

Downloading Images

Camera Settings

Remote Shooting

Preferences

Reference

Index

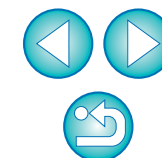



## Communication between EU and the camera disconnected

- Operation of the auto power off function will automatically switch the camera off, disabling communication with EU, if you turn the auto power off function to [ON]. Remove the check mark from [Auto power off] in the preferences ([Basic Settings] window) (p.74) or set the auto power off function in the camera to [OFF].
- If you do not perform any operation while the camera and computer are connected, depending on the computer system, a confirmation message may appear on the screen asking whether you wish to continue communicating with the camera. If you do not perform an operation while this message appears, communication with your camera is discontinued and EU shuts down. In this case, turn the camera's power switch to < OFF >, then again to < ON > and start up EU.
- Do not put your computer to sleep while it is connected to the camera. If your computer goes into sleep mode, never disconnect the interface cable while your computer is still in sleep mode. Always wake your computer up while it is still connected to the camera. Depending on the type of computer, disconnecting the interface cable while your computer is in sleep mode could prevent the computer from waking up correctly. Refer to the computer User's Manual for more information on sleep mode.

## A non-Canon flash does not fire during Remote Live View shooting

- When a non-Canon flash is mounted on the camera for Remote Live View shooting, set [Silent shooting] in the camera to [Disable].

## Remotely shot images using EU are not displayed in DPP

- In Digital Photo Professional, select the [Tools] menu ► [Sync folder with EOS Utility].

Introduction

Contents at a Glance

Downloading Images

Camera Settings

Remote Shooting

Preferences

Reference

Index

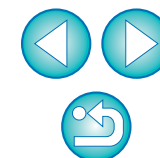

# Monitor Folder Function (Function for Use with the WFT-E2, WFT-E2 II, WFT-E3, WFT-E4, WFT-E4 II, WFT-E5, WFT-E6, or WFT-E7)

This is a function for checking your images with Digital Photo Professional (hereinafter DPP) in real time using the Wireless File Transmitter WFT-E2, WFT-E2 II, WFT-E3, WFT-E4, WFT-E4 II, WFT-E5, WFT-E6, or WFT-E7 (sold separately).

For setting the WFT-E2, WFT-E2 II, WFT-E3, WFT-E4, WFT-E4 II, WFT-E5, WFT-E6, or WFT-E7 refer to the Instruction Manual provided with each product.

## 1 Click [Monitor Folder].



→ The [Monitor Folder] dialog box appears.

## 2 Click the [Browse] button and specify the save destination folder for shot images.

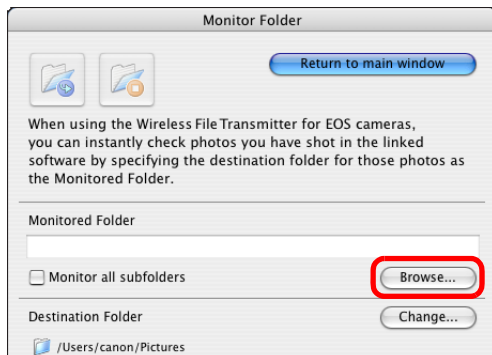

- You can specify the save destination folder for the shot images set in the WFT-E2, WFT-E2 II, WFT-E3, WFT-E4, WFT-E4 II, WFT-E5, WFT-E6, or WFT-E7.

## 3 Click the [Change] button and specify the transfer destination folder.

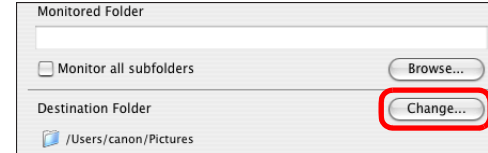

## 4 Click the [ ] button.

→ Image transfer preparation is complete.

## 5 Take a shot.

→ If images are saved in the folder specified in step 2, they are transferred/saved in the folder specified in step 3.

→ DPP starts up and the images saved in the folder specified in step 3 are displayed.

**!** You cannot specify the same folders in step 2 and step 3.

**!** You can change the software that starts up in step 5, from DPP to ImageBrowser EX or other software in preferences ([Linked Software] window) (p.77).

Introduction

Contents at a Glance

Downloading Images

Camera Settings

Remote Shooting

Preferences

Reference

Index

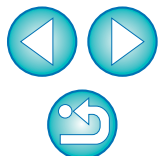

# Function for Use with the Accessories

If you have the Wireless File Transmitter WFT-E2, WFT-E2 II, WFT-E3, WFT-E4, WFT-E4 II, or WFT-E5 (sold separately), you can start up the previously mentioned accessory software from EU. And you can also start up the Picture Style Editor (Picture Style file creating software). For details on using each software, refer to the instruction manual for the software. For Picture Style files, see [p.18](#).

**1** Connect your camera and computer, and then start up EU ([p.5](#)).

**2** Click the [Accessories] tab.

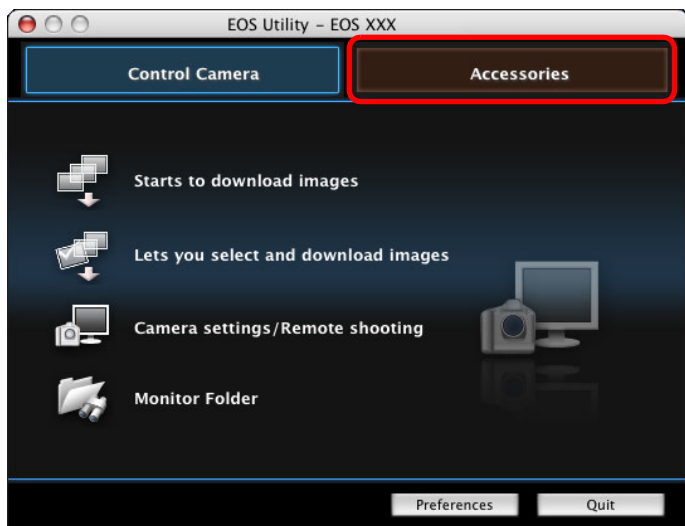

→ The [Accessories] tab sheet appears.

**3** Click the software you want to start up.

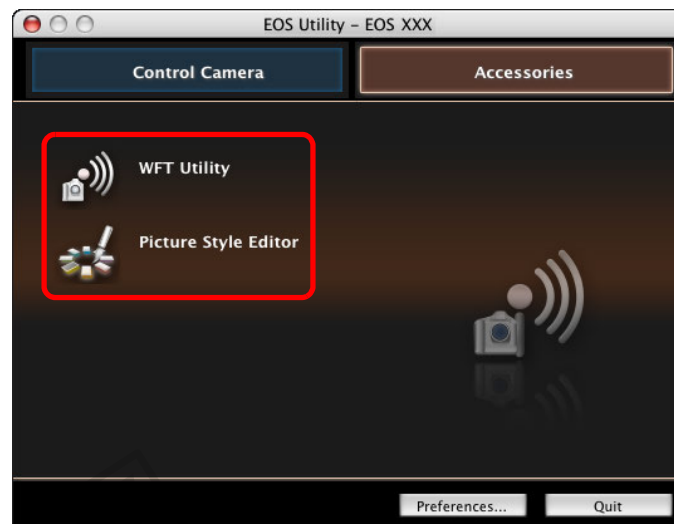

→ The clicked software starts up.

Introduction

Contents at a Glance

Downloading Images

Camera Settings

Remote Shooting

Preferences

Reference

Index

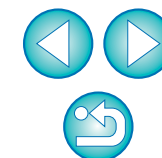

## Folder Structure and File Names in the Memory Card

Images shot with the camera are saved in the memory card's [DCIM] folder with the following folder structure and file names. Refer to the following when copying images to your computer using a card reader.

	File name	File type
	****YYYY.JPG	JPEG image file
	****YYYY.CR2	RAW image file
	****YYYY.MOV	MOV movie file
	****YYYY.THM	Thumbnail file
****YYYY.WAV	Audio file	

- The camera specific character string set at the time of factory shipment or set in the camera appears in “\*\*\*\*” of the file name.
- The “YYYY” in the file names represents a number between 0001 and 9999.

Contains a file allowing the camera to manage the images in the [DCIM] folder.

- The “xxx” in the folder names represents a number between 100 and 999.
- For the 1D series cameras, the folder structure is the same for CF cards and SD cards.
- When you perform DPOF settings on the camera, a [MISC] folder is created. The files that manage the DPOF settings are saved in the [MISC] folder.
- When you register background music on **REBELT4i** **650D** **REBELT3i** **600D**, a MUSIC folder is generated for registering music files and WAV files are saved there.
- A thumbnail file is a file saved with the same file name as the movie and that includes shooting information. When a movie is shot with **1D Mk IV** **5D Mk II** **7D** **REBELT2i** **550D** or **REBELT1i** **500D**, it is generated together with the movie file.
- When you play on the camera a movie that was shot with **1D Mk IV** **5D Mk II** **7D** **REBELT2i** **550D** or **REBELT1i** **500D**, both the movie file and the thumbnail file are required.

When Adobe RGB is specified, the file names of images shot with your camera have an underscore “\_” as the first character.

## Uninstalling the Software

- Before starting the software uninstallation, quit all programs you are using.
- To uninstall the software, log into the account used when installation was performed.
- When you have moved the folders and the software to be deleted to the Trash, select the [Finder] menu ► [Empty Trash] and empty the Trash. You cannot reinstall the software until you have emptied the Trash.

### 1 Display the folder in which the software is saved.

- Open the [Canon Utilities] folder.



### 2 Drag the [EOS Utility] folder to the Trash.

### 3 Select the [Finder] menu on the desktop ► [Empty Trash].

→ EU is uninstalled.

### 4 Restart your computer.

**!** You cannot retrieve data that you have emptied into the Trash and deleted, so be particularly careful when deleting data.

Introduction

Contents at a Glance

Downloading Images

Camera Settings

Remote Shooting

Preferences

Reference

Index

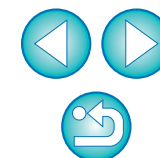

# Fixing the Plug to the Camera



1D X

1D Mk IV

1Ds Mk III

1D Mk III

Fasten the plug to the camera with the cable protector to prevent it from detaching during remote shooting.

1D X

- 1 Open the cover, and connect the small plug of the cable to the camera's <A/V OUT / DIGITAL> terminal.

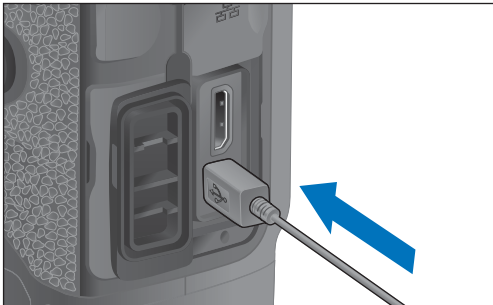

- Check the direction of the <↔> mark on the plug and push it in.

- 2 Attach the cable protector in the order (1), (2).

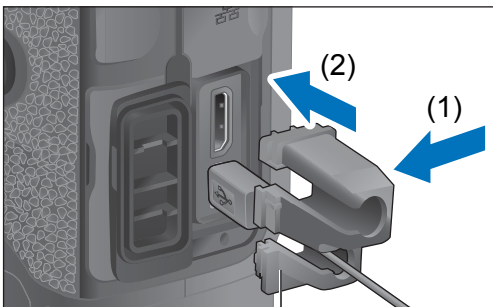

Cable protector

Cable protector attached.

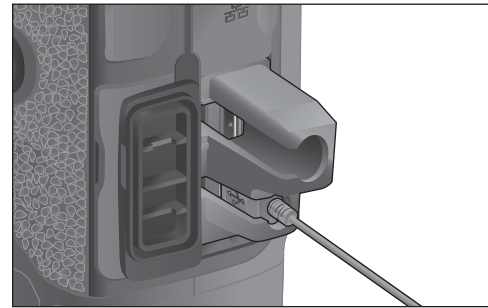

- 3 Remove the cable protector in the order (1), (2).

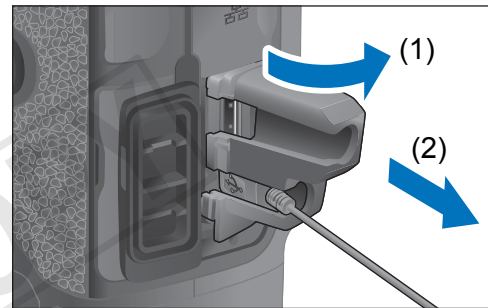

Introduction

Contents at a Glance

Downloading Images

Camera Settings

Remote Shooting

Preferences

Reference

Index

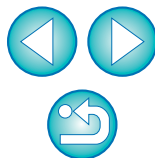

1D Mk IV

# 1 Open the covers.

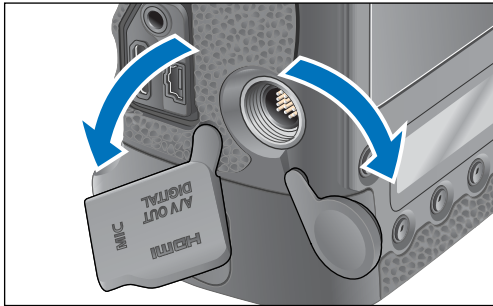

# 2 Pass the small plug of the cable through the cable protector, and pull it in the direction of the arrow.

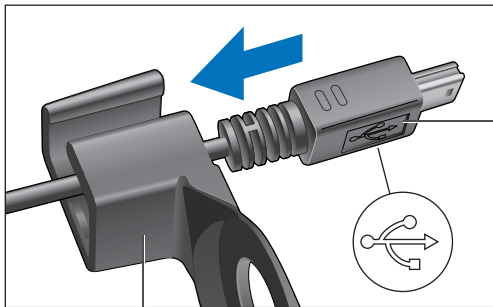

< USB > mark

Cable protector

- Check the direction of the < USB > mark on the plug and pull it in.

# 3 With the plug as it is in step 2, connect it to the camera's <A/V OUT / DIGITAL> terminal.

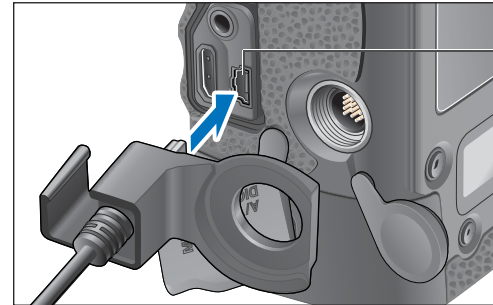

<A/V OUT / DIGITAL> terminal

# 4 Fix the cable protector with the fixing screw.

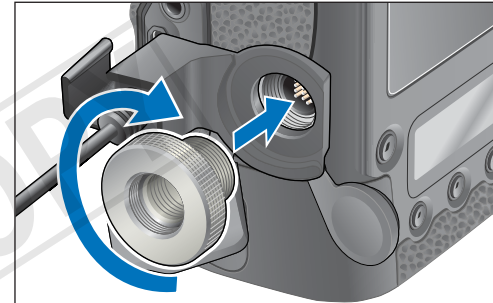

Introduction

Contents at a Glance

Downloading Images

Camera Settings

Remote Shooting

Preferences

Reference

Index

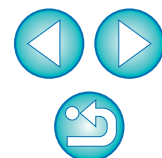

1Ds Mk III 1D Mk III

### 1 Remove the cap.

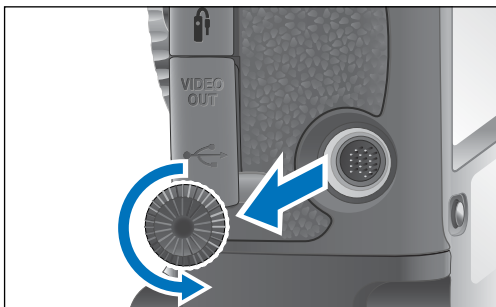

### 2 Attach the cap on the fixing screw.

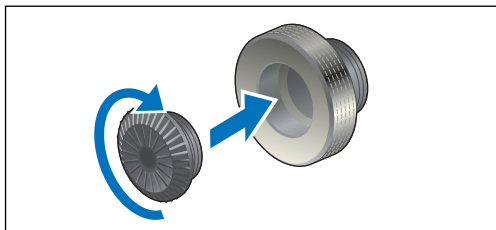

### 3 Connect the small plug of the cable into the <img alt="USB symbol" data-bbox="385 548 415 575"/> terminal on your camera.

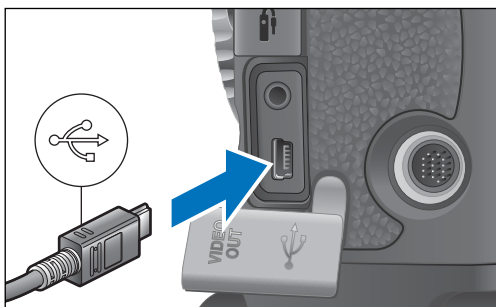

- Connect the plug with the <img alt="USB symbol" data-bbox="225 815 255 842"/> mark facing the front of the camera.

### 4 Attach the cable protector and fix it with the fixing screw.

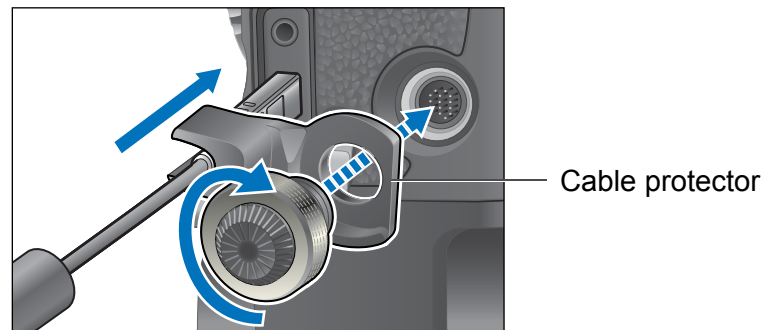

Introduction

Contents at a Glance

Downloading Images

Camera Settings

Remote Shooting

Preferences

Reference

Index

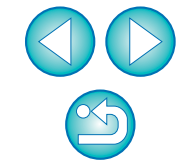

# List of Main Window Functions

## Control camera tab sheet



(p.6)

(p.7, p.88)

(p.27, p.91)

(p.81)

(p.74)

Quits EU (p.10)

- The window below appears when **REBELT4i**, **650D**, **REBELT3i**, **600D** is connected.



(p.70)

## Accessories tab sheet



(p.82)

Introduction

Contents at a Glance

Downloading Images

Camera Settings

Remote Shooting

Preferences

Reference

Index

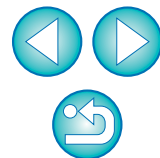



# List of Viewer Window Functions (p.7)

The screenshot shows the EOS Utility viewer window with the following labels and functions:

- Switches the recording media**: Points to the recording media folder hierarchy on the left.
- Recording media folder hierarchy**: Points to the 'All' and '100CANON' folders.
- Recording time**: Points to the time display above the image thumbnails.
- Movie icon**: Points to the movie icon in the top toolbar.
- Bracketing icon**: Points to the bracketing icon in the top toolbar.
- Images already transferred to computer icon**: Points to the icon in the top toolbar.
- Selects the condition of the image**: Points to the 'Invert selection' button.
- Video Snapshot album icon**: Points to the video snapshot icon in the top toolbar.
- Rating icon\***: Points to the star rating icons below the thumbnails.
- RAW image icon**: Points to the RAW image icon in the top toolbar.
- Protect icon**: Points to the protect icon in the top toolbar.
- Audio recording icon**: Points to the audio recording icon in the top toolbar.
- RAW + JPEG image icon**: Points to the RAW + JPEG icon in the top toolbar.
- Image display size**: Points to the 'Large' button in the bottom right.
- Quits EU**: Points to the 'Quit' button in the bottom right.
- Displays the main window**: Points to the 'Main Window...' button.
- Displays the [Preferences] window**: Points to the 'Preferences...' button.
- Check mark (p.8)**: Points to the checkmark icon in the bottom toolbar.
- Deletes the image**: Points to the delete icon in the bottom toolbar.
- Downloads the images to the computer**: Points to the download icon in the bottom toolbar.
- Displays the quick preview window**: Points to the quick preview window icon in the bottom toolbar.
- Displays the capture window**: Points to the capture window icon in the bottom toolbar.

Introduction

Contents at a Glance

Downloading Images

Camera Settings

Remote Shooting

Preferences

Reference

Index

\* Ratings set on 1D X, 5D Mk III, 7D (firmware version 2.0.0 or later), 60D, REBELT4i, 650D, REBELT3i, 600D, REBELT3, 1100D, Digital Photo Professional Ver. 3.9 or later is displayed. However, the [Reject] rating is not displayed. Also, ratings cannot be set in EU.

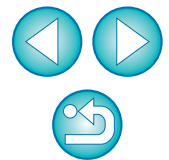

# List of Register Data Window Functions for Lens Aberration and Peripheral Illumination Correction (p.22)

Introduction

Contents at a Glance

Downloading Images

Camera Settings

Remote Shooting

Preferences

Reference

Index

Displays all the categories

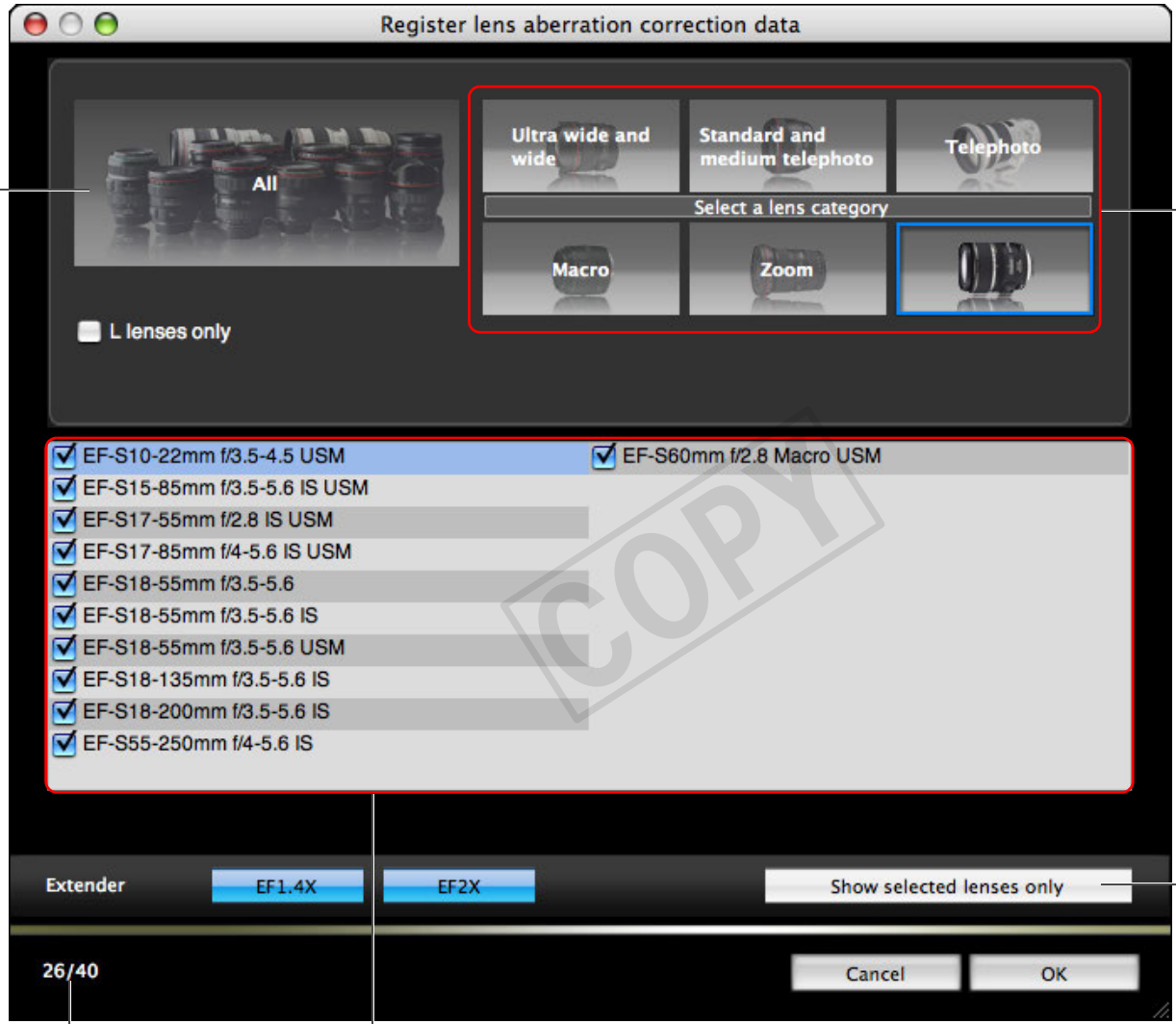

Lens category

Displays only the registered lenses

Displays lenses selected in [Select a lens category] by category

No. of lenses registered in the camera/No. of lenses that can be registered

 Lens names displayed in the [Register lens aberration correction data] window/ [Register peripheral illumination correction data] window may be partially shortened depending on the lens type.

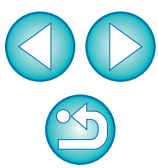

# List of My Menu Settings Window Functions (p.24)

Introduction

Contents at a Glance

Downloading Images

Camera Settings

Remote Shooting

Preferences

Reference

Index

The screenshot shows the 'My Menu settings' window with the following annotations:

- Switches My Menu position:** Points to the top bar of the window.
- Items that can be configured in My Menu on the camera:** Points to the left list containing 'White balance', 'Color space', 'Picture Style', and 'Protect images'.
- My Menu (up to 6 items):** Points to the left list.
- Deletes from My Menu:** Points to the 'Delete' button.
- Applies My Menu to the camera:** Points to the 'Apply to camera' button.
- Adds to My Menu:** Points to the 'Add' button.
- Switches My Menu position:** Points to the top bar of the window.
- All items that can be applied to My Menu:** Points to the right list containing various camera settings like 'White balance', 'Custom WB regist.', 'WB SHIFT/BKT', 'Color space', 'Picture Style', 'JPEG Quality', 'Image Size', 'Review time', 'Beep', 'Shoot w/o card', 'Dust Delete Data', 'Protect images', 'Rotate', and 'Erase images'.
- Closes [My Menu settings] window:** Points to the 'Close' button.

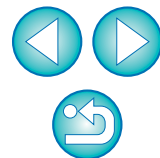

# List of Capture Window Functions

- Displayed items differ depending on the model and settings of the camera connected.
- For \*1 to \*11 explanations, see the next page.

Flash ready\*2

Mirror lockup

Drive mode

Bracketing\*10

Power status\*1

Number of possible shots

Shooting mode\*11

Color temperature

White balance

Metering mode

Exposure Level/AEB Level  
(See next page for details)

Displays the [Shooting menu] (p.15)

Displays [Flash control menu] (p.93)

Displays the [Remote Live View window]  
(p.31, p.95)

Displays the [Preferences] window (p.74)

Displays the main window (p.87)

AF mode

Warning lamp\*3

Rotates shot images\*4

Shoot button\*5 (p.32)

AF/MF selector button\*6

Save destination for shot images

Shutter speed

Aperture\*7

ISO speed

Image recording quality

Save destinations for shot images\*8

Displays the [Timer shooting settings] window  
(p.64, p.65)

Displays the [My Menu] (p.25)

Displays the [Set-up menu] (p.13)

Displays the [Remote Live View window (Movie)]\*9  
(p.56, p.58, p.60)

Displays the viewer window (p.8, p.88)  
Shows/hides the [Quick Preview] window  
Displays the [Test Shooting] window (p.41, p.98)

Introduction

Contents at a Glance

Downloading Images

Camera Settings

Remote Shooting

Preferences

Reference

Index

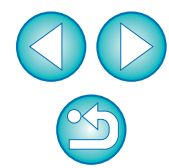

- \*1 When using the battery, the charge level is displayed.
- \*2 Displayed only on 1D X, 1D Mk IV, 5D Mk III, 7D, 60D, REBELT4i, 650D, REBELT3i, 600D, REBELT2i, 550D, REBELT3, 1100D .  
Appears after flash charging is complete and the cursor is moved to the Shoot button.
- \*3 Turns on red when shooting was unsuccessful or is impossible. Also blinks during countdown for self-timer shooting.
- \*4 Each time you click the button, the shot image rotates 90 degrees. To make this function available, checkmark [Rotate image] in preferences ([Remote Shooting] window) (p.76).
- \*5 On 1D X, 1D Mk IV, 5D Mk III, 5D Mk II, 7D, 60D, 50D, REBELT4i, 650D, REBELT3i, 600D, REBELT2i, 550D, REBELT1i, 500D, REBELT3, 1100D , when the AF/MF selector button is set to [AF], AF/AE is performed when the cursor is moved to the Shoot button.
- \*6 Displayed only on 1D X, 1D Mk IV, 5D Mk III, 5D Mk II, 7D, 60D, 50D, REBELT4i, 650D, REBELT3i, 600D, REBELT2i, 550D, REBELT1i, 500D, REBELT3, 1100D . Even when it is set to [MF], "AF" appears in the shooting information for the shot image. Setting < A-DEP > as the camera's shooting mode disables this button.
- \*7 Click the aperture while holding down the <control> key, and you can decrease the aperture by pressing <O> on the keyboard, or increase the aperture by pressing <C>.
- \*8 You can select whether the shot images are saved only to the computer or both to the computer and to the memory card in the camera. In movie mode, shot movies are saved only to the camera's memory card.
- \*9 Displayed only on 5D Mk III, 7D, 60D, REBELT4i, 650D, REBELT3i, 600D, REBELT2i, 550D, REBELT3, 1100D .
- \*10 During HDR (High Dynamic Range) shooting on 5D Mk III , the icon is displayed as [HDR]. REBELT4i, 650D When [Multi Shot Noise Reduction] is set, the icon is displayed as [NR].
- \*11 1D X, 5D Mk III You can also set custom shooting mode C1, C2, and C3.

## Exposure Level/AEB Level

- The display changes as follows by double-clicking the Exposure level/AEB level item.

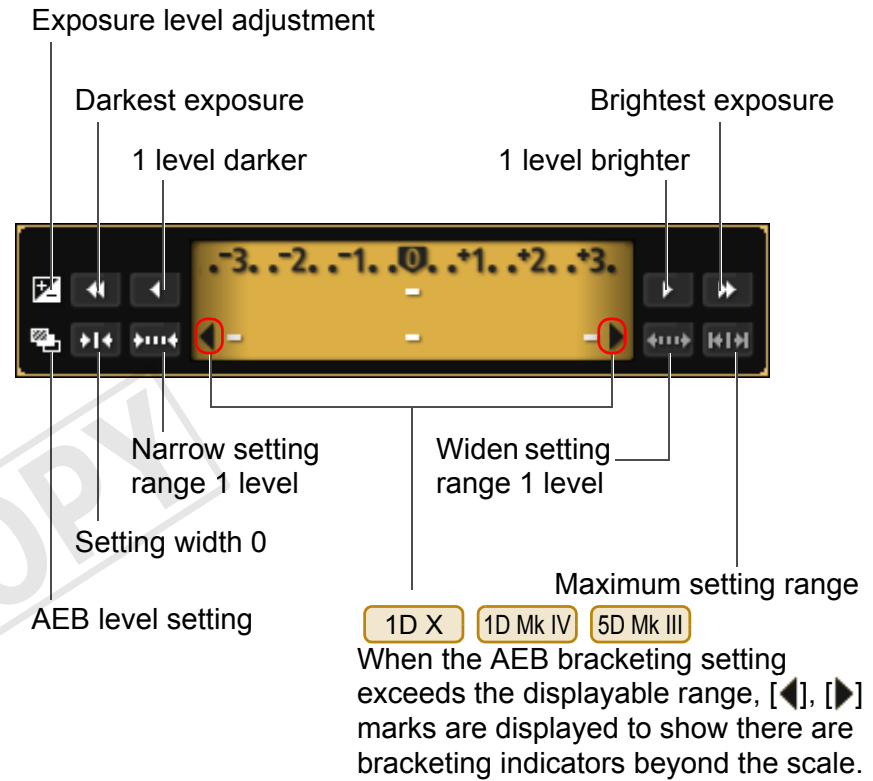

- Display appears as follows if [2 shots] is set for AEB shooting on 1D X, 5D Mk III .

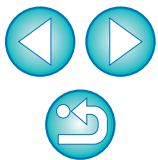

# List of Flash Function Settings Window Functions (p.66)



1D X 1D Mk IV 5D Mk III 5D Mk II 7D 60D REBELT4i 650D REBELT3i 600D REBELT2i 550D REBELT3 1100D \*1

MULTI flash count: 40 times

1st curtain sync/ 2nd curtain sync/ Hi-speed sync

Flash firing:

Settings update button

Flash mode: E TTL

Zoom/focal length: 105 mm

Flash metering: Evaluative

MULTI flash frequency: 199 Hz

Flash exposure compensation amount/Flash output level\*2: -3..-2..-1..0..+1..+2..+3

Wireless func. Enable

Wireless function button

Channel: CH. 1

Master flash ON/OFF:

Flash ratio: A:B:C

Flash exposure compensation amount/Flash output level\*2 during wireless setting:

A	1/128	1/64	1/32	1/16	1/8	1/4	1/2	1/1
B	1/128	1/64	1/32	1/16	1/8	1/4	1/2	1/1
C	1/128	1/64	1/32	1/16	1/8	1/4	1/2	1/1

[Modeling flash] button

[Save] button: Save

[Load] button: Load...

Close

Introduction

Contents at a Glance

Downloading Images

Camera Settings

Remote Shooting

Preferences

Reference

Index

\*1 The window displayed differs depending on the connected camera and flash.

\*2 Displayed information differs depending on the settings. For more details on settings, also refer to the Instruction Manual provided with your EX-series Speedlite or camera.

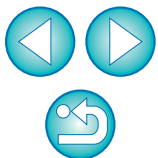

The screenshot shows the 'Flash function settings' menu. At the top, there is a 'Flash firing' checkbox which is checked. Below it, the 'Flash mode' is set to 'ETTL'. The 'Zoom' is set to '24 mm', 'MULTI flash frequency' is '40 Hz', and 'MULTI flash count' is '4 times'. The 'Syncro setting' is set to 'Evaluative'. A red box highlights the 'Flash exposure compensation amount / Flash output level' range from -3 to +3. The 'Wireless func.' section shows 'Channel' set to '5', 'ID' as '0000', and 'Flash ratio' as 'A:B C'. A table below shows settings for channels A, B, C, D, and E, all set to 'ETTL' with a range from -3 to +3. At the bottom, there are buttons for 'Save...', 'Load...', and 'Close', along with a 'Modeling flash' button.

Flash metering

Zoom/focal length

MULTI flash frequency

MULTI flash count

Flash firing

Flash mode

ETTL

Zoom

24 mm

40 Hz

4 times

Settings update button

Flash exposure compensation amount / Flash output level\*2

Syncro setting\*1

Evaluative

Wireless function button

Wireless radio ID

Flash ratio

Channel

5

ID 0000

RATIO

A:B C

Master flash ON/OFF

Flash exposure compensation amount / Flash output level during wireless setting\*2

A

ETTL

-3..-2..-1..0..+1..+2..+3

B

ETTL

-3..-2..-1..0..+1..+2..+3

C

ETTL

-3..-2..-1..0..+1..+2..+3

D

ETTL

-3..-2..-1..0..+1..+2..+3

E

ETTL

-3..-2..-1..0..+1..+2..+3

[Modeling flash] button

[Save] button

Save...

Load...

Close

[Load] button

\*1 1st curtain sync/ 2nd curtain sync/ Hi-speed sync

\*2 Displayed information differs depending on the settings. For more details on settings, also refer to the Instruction Manual provided with your EX-series Speedlite or camera.

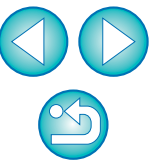

# List of Remote Live View Window (Live View Tab) Functions (p.27)

Enlargement display frame

Sets the color temperature

Controllers 1

AF point

Movie recording time

Movie recording in progress icon

1D X 5D Mk III

Movie recording format

Frame rate

Movie recording size

Starts/stops movie recording

Displays the capture window (p.91)

1D X 5D Mk III

Show/hide electronic level (p.43)

1D X 5D Mk III

Auto rotation button\*1

Shows/hides the AF points

Rotates the image\*2

Displays the [Zoom View] window (p.35, p.97)

Shows/hides the histogram

Sets the aspect ratio (p.44)

Selects the white balance (p.41)

Click white balance

Displays the [Test Shooting] window (p.98)

AF mode (p.36 to p.40)

Lens drive (p.36)

Checks the depth of field (p.40)

Shows/hides the controllers 1

Recording level settings (p.45)

Controllers 2

Closes the window

\*1 When automatic rotation is set, the [Remote Live View window] display also rotates automatically to match the camera's rotation when it is detected that the camera is held vertically.

\*2 When [AUTO] is set to ON, the [rotation icon] [rotation icon] buttons cannot be used to rotate images.

Introduction

Contents at a Glance

Downloading Images

Camera Settings

Remote Shooting

Preferences

Reference

Index

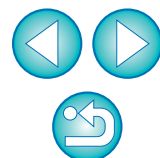



# List of Remote Live View Window (Compose Tab) Functions [\(p.47\)](#)

Overlay image filename

Overlay image controllers

Opens an overlay image [\(p.47\)](#)

Overlay image move and display [\(p.50\)](#)

Enlarge/reduce slider [\(p.48\)](#)

Rotate slider [\(p.49\)](#)

Composite ratio slider [\(p.49\)](#)

Resets the overlay image [\(p.48\)](#) to [\(p.50\)](#)

Grid display [\(p.51\)](#) to [\(p.52\)](#)

Introduction

Contents at a Glance

Downloading Images

Camera Settings

Remote Shooting

Preferences

Reference

Index

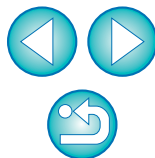

# List of Zoom View Window Functions (p.35)

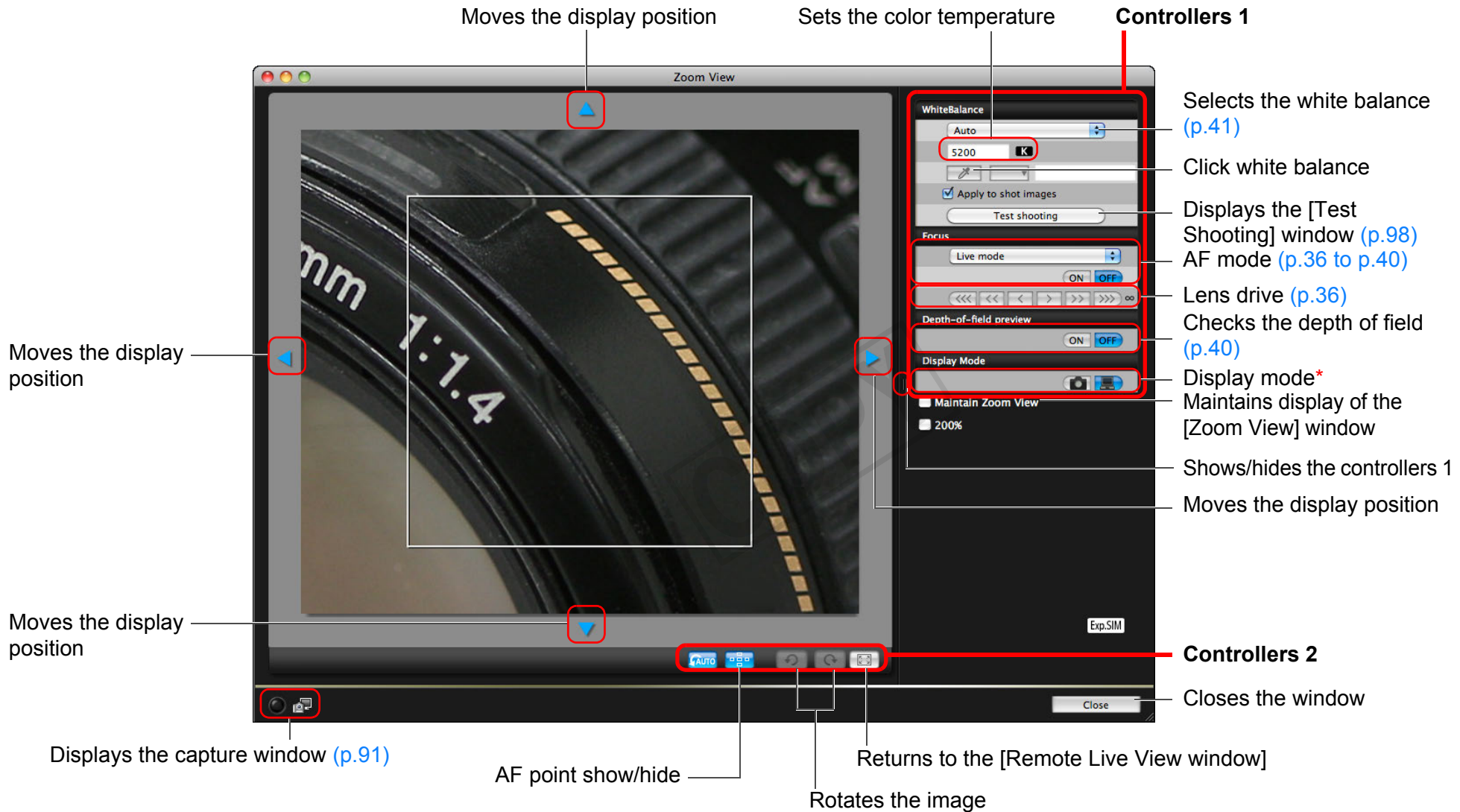

\* Clicking the [📷] button switches to a quality suited to focusing while viewing on your camera's LCD monitor; clicking the [💻] button switches to a quality suited to focusing while viewing on your computer.

- Introduction
- Contents at a Glance
- Downloading Images
- Camera Settings
- Remote Shooting
- Preferences
- Reference
- Index

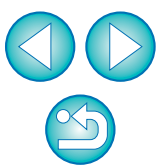

# List of Test Shooting Window Functions (p.41)

Introduction

Contents at a Glance

Downloading Images

Camera Settings

Remote Shooting

Preferences

Reference

Index

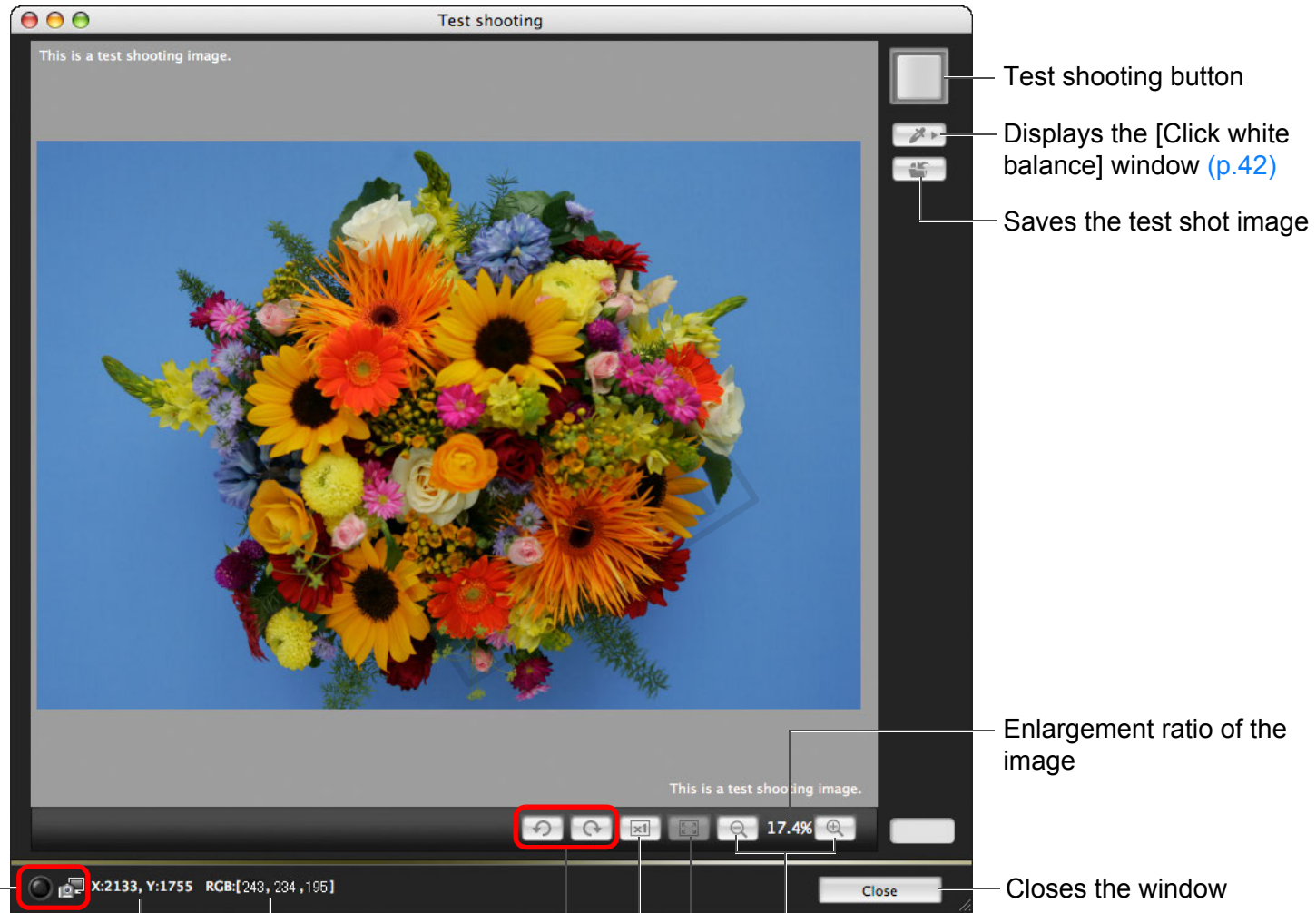

Displays the capture window

Coordinates

RGB values

Rotates the image

100% (actual pixel size) view

Fit-to-window view

Enlargement/reduction of the image

Enlargement ratio of the image

Closes the window



# Index

## A

Adjusting the Horizontal Alignment of the Camera (Remote Live View Shooting) .....	43
Adjusting the Vertical Alignment of the Camera (Remote Live View Shooting) .....	43
Adjusting the White Balance .....	22
Applying Personal White Balance .....	20
Applying Picture Style Files .....	18
Attaching the Cable Protector .....	86

## B

Basic Settings (Preferences) .....	74
Bulb Exposures .....	65

## C

Capture Window .....	91
Flash Control Menu .....	67
My Menu .....	25
Set-up Menu .....	13
Shooting Menu .....	15
Changing the Aspect Ratio (Remote Live View Shooting) .....	44
Changing the White Balance in the Remote Live View Window (Remote Live View Shooting) .....	41
Checking the Depth of Field and Exposure (Remote Live View Shooting) .....	40
Connecting the Camera to Your Computer .....	5

## D

Destination Folder Settings (Preferences) .....	74
Download Images Settings (Preferences) .....	75
Downloading All the Images in a Single Operation .....	6
Downloading Images with a Card Reader .....	10
Downloading Selected Images .....	7

## F

File Name Settings (Preferences) .....	75
Flash Control Menu (Capture Window) .....	67
Flash function settings Window .....	68, 93

Flash shooting .....	66
Focusing Automatically (Using AF) (Remote Live View Shooting) .....	36
Focusing in Face Detection Live Mode (Remote Live View Shooting) .....	39
Focusing in Live Mode (Remote Live View Shooting) .....	38
Focusing in Quick Mode (Remote Live View Shooting) .....	36
Focusing Manually (Remote Live View Shooting) .....	35
Focusing Using AF .....	36
Folder Structure and File Names .....	83
Folder Structure and File Names in the Memory Card .....	83
Function for Use with WFT-E2, WFT-E2 II, WFT-E3, WFT-E4, WFT-E4 II, WFT-E5, WFT-E6, or WFT-E7 .....	81

## I

Interval Timer Shooting .....	64
-------------------------------	----

## L

Linked Software Settings (Preferences) .....	77
--	----

## M

Main Window .....	87
My Menu (Capture Window) .....	25
My Menu Settings .....	24
My Menu Settings Window .....	25, 90

## O

Overlaid Display Function (Remote Live View Shooting) .....	47
---	----

## Q

Quitting the EOS Utility .....	10
--------------------------------	----

## R

Register Lens Aberration Correction Data/Register Peripheral Illumination Correction Data Window .....	23, 89
Registering Background Music to a Camera Memory Card .....	70
Registering Lens Aberration Correction/Peripheral Illumination Correction Data for the Lens .....	22
Remote Live View Shooting .....	27
Remote Live View Window .....	31, 95

Introduction

Contents at a Glance

Downloading Images

Camera Settings

Remote Shooting

Preferences

Reference

Index

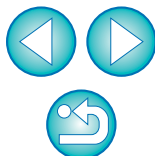

Remote Live View Window Functions.....	35
Adjusting the Horizontal Alignment of the Camera.....	43
Adjusting the Vertical Alignment of the Camera.....	43
Changing the Aspect Ratio.....	44
Changing the White Balance in the Remote Live View Window ..	41
Checking the Depth of Field and Exposure.....	40
Focusing Automatically (Using AF).....	36
Focusing in Face Detection Live Mode.....	39
Focusing in Live Mode.....	38
Focusing in Quick Mode.....	36
Focusing Manually.....	35
Overlaid Display Function.....	47
White Balance for Flash Photography.....	41
Remote Shooting Settings (Preferences).....	76
<b>S</b>	
Setting JPEG Quality.....	21
Setting Picture Styles.....	16
Setting the Camera Owner's Name.....	12
Setting the Camera's Date and Time.....	12
Setting the Copyright Notice for the Image.....	12
Set-up Menu (Capture Window).....	13
Shooting by Operating the Camera.....	52
Shooting Menu (Capture Window).....	15
Shooting Movies.....	53
Specifying Preferences.....	74
Basic Settings.....	74
Destination Folder Settings.....	74
Download Images Settings.....	75
File Name Settings.....	75
Linked Software Settings.....	77
Remote Shooting Settings.....	76
Time Settings.....	77
Starting up EOS Utility.....	6
Supported Camera.....	2
System Requirements.....	2

<b>T</b>	
Test Shooting Window.....	41, 98
Time Settings (Preferences).....	77
Timer Shooting.....	64
<b>U</b>	
Uninstalling the Software.....	83
<b>V</b>	
Viewer Window.....	8, 88
<b>W</b>	
White Balance for Flash Photography (Remote Live View Shooting) .	41
<b>Z</b>	
Zoom View Window.....	35, 97

## About This Instruction Manual

- It is prohibited to reproduce, in whole or part, the contents of this Instruction Manual without permission.
- Canon may change without notice the software specifications and contents of this Instruction Manual.
- The software screens and displays printed in this Instruction Manual may differ slightly from the actual software.
- The content of this Instruction Manual has been reviewed thoroughly. However, if you should notice any errors or omissions, please contact a Canon Service Center.
- Please note that irrespective of the above-mentioned, Canon does not take responsibility for the outcome of the operation of the software.

## Trademark Acknowledgments

- Macintosh is trademark of Apple Inc., registered in the United States and other countries.
- Other names and products not mentioned above may be registered trademarks or trademarks of their respective companies.

Introduction

Contents at a Glance

Downloading Images

Camera Settings

Remote Shooting

Preferences

Reference

Index

